



ALITHA

INDUSTRIAL CORPORATION

**PRODUCT
CATALOG** 2026





Table of Contents

Drawer Guides & Sliding Mechanisms	4-5
Furniture Hinges & Lift Mechanisms	6-9
Drawer System	10-13
Kitchen Accessories & Storage Solutions	14-22
Electric Lift Kitchen Storage Technology	23-24
Cutlery Trays & Drawer Inserts	25-28
Waste Storage System	29
Wardrobe Accessories & Fittings	30-36
Furniture Fittings	38-39
Smart Push, Locks & Catches	40
Furniture Handles, Gola System & Continuous Grab Handle	41-43
Cabinet Sliding Door System	44-52
Partition Sliding Door System	53-59
Hotmelt Glue for Furniture Edgebanding	60
Laminated Boards & Interior Surface Solutions	61-63

DRAWER GUIDES & SLIDING MECHANISMS



FULL EXTENSION BALL BEARING SLIDES

Brand: ALTUS
Material: Epoxy Powder Coated Steel
Thickness: 1.2 x 1.2 x 1.5mm
Finish: Black
Salt Spray Test: 24hrs
Open Close Test: 50,000 Cycles
Capacity: 45kgs.
Packing: Per Pair, with Screws



CODE	SIZE	CODE	SIZE
RHS11-01300.BLK	12"/300mm	RHS11-01450.BLK	18"/450mm
RHS11-01350.BLK	14"/350mm	RHS11-01500.BLK	20"/500mm
RHS11-01400.BLK	16"/400mm	RHS11-01550.BLK	22"/550mm

SOFT CLOSE FULL EXTENSION BALL BEARING SLIDES

Brand: ALTUS
Material: Epoxy Powder Coated Steel
Thickness: 1.2 x 1.2 x 1.5mm
Finish: Black/Zinc Plated
Salt Spray Test: 24hrs
Open Close Test: 50,000 Cycles
Capacity: 45kgs.
Packing: Per Pair, with Screws



CODE	SIZE	CODE	SIZE
RHS11-02300.ZNC	12"/300mm	RHS11-02450.ZNC	18"/450mm
RHS11-02300.BLK	12"/300mm	RHS11-02450.BLK	18"/450mm
RHS11-02350.ZNC	14"/350mm	RHS11-02500.ZNC	20"/500mm
RHS11-02350.BLK	14"/350mm	RHS11-02500.BLK	20"/500mm
RHS11-02400.ZNC	16"/400mm	RHS11-02550.ZNC	22"/550mm
RHS11-02400.BLK	16"/400mm	RHS11-02550.BLK	22"/550mm

PUSH OPEN FULL EXTENSION BALL BEARING SLIDES

Brand: ALTUS
Material: Epoxy Powder Coated Steel
Thickness: 1.2 x 1.2 x 1.5mm
Finish: Black
Salt Spray Test: 24hrs
Open Close Test: 50,000 Cycles
Capacity: 45kgs.
Packing: Per Pair, with Screws



CODE	SIZE
RHS11-03300.BLK	12"/300mm
RHS11-03350.BLK	14"/350mm
RHS11-03400.BLK	16"/400mm
RHS11-03450.BLK	18"/450mm
RHS11-03500.BLK	20"/500mm

CONCEALED SOFT CLOSE FULL EXTENSION SLIDES

with 3D Handles

Brand: ALTUS
Material: Galvanized Steel
Thickness: 1.8 x 1.5 x 1.0mm
Finish: Zinc Plated
Salt Spray Test: 24hrs
Open Close Test: 50,000 Cycles
Capacity: 35kgs.
Packing: Per Pair, with Screws

Screw Positions (Proposal of Fixing Screws)
 NL: Nominal Length

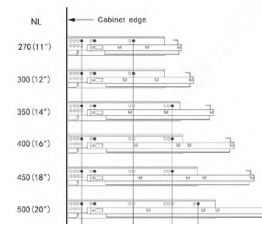

CODE	SIZE	CODE	SIZE
RHS11-04300.ZNC	12"/300mm	RHS11-04450.ZNC	18"/450mm
RHS11-04350.ZNC	14"/350mm	RHS11-04500.ZNC	20"/500mm
RHS11-04400.ZNC	16"/400mm	RHS11-04550.ZNC	22"/550mm

Space Requirement in Cabinet
 SKW: Internal Drawer Width
 LW: Internal Cabinet Width

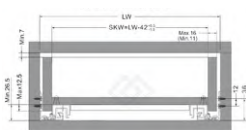

Inner Drawer



Standard Drawer

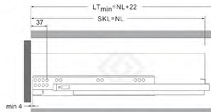

CONCEALED PUSH OPEN FULL EXTENSION SLIDES

with 3D Handles

Brand: ALTUS
Material: Galvanized Steel
Thickness: 1.8 x 1.5 x 1.0mm
Finish: Zinc Plated
Salt Spray Test: 24hrs
Open Close Test: 50,000 Cycles
Capacity: 35kgs.
Packing: Per Pair, with Screws



CODE	SIZE
RHS11-05400.ZNC	16"/400mm
RHS11-05450.ZNC	18"/450mm
RHS11-05500.ZNC	20"/500mm

SOFT CLOSE-PUSH OPEN CONCEALED GUIDES

with Synchronization Rod & 3D Adjustment

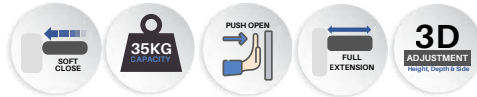

Brand: ALTUS
Material: Galvanized Steel
Thickness: 1.8 x 1.5 x 1.0mm
Finish: Zinc Plated
Push Open Gap: 2.5mm
Front Panel Gap: -2.5to +4mm
Board Thk: 18mm (450mm as standard)
3D Adjustment: H0+3mm/W =-1.5mm
Capacity: 35kgs.
Packing: Per Pair, with Screws

Stabilizer Rod: 900mm-1200mm Drawer width

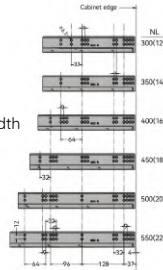

Installation Dimensions: mm
 NL: Nominal Length
 LT: Internal Cabinet Depth
 X: Front Panel Thickness

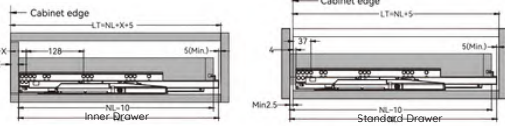

CODE	SIZE
RHS11-06400	16"/400mm
RHS11-06450	18"/450mm
RHS11-06500	20"/500mm
RHS11-06550	22"/550mm
RHS11-06600	24"/600mm

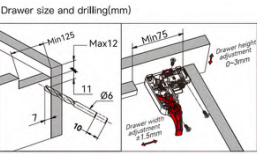

Installation Dimensions: mm
 SKW: Internal Drawer Width
 LW: Internal Cabinet Width

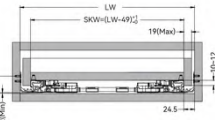

PULL-OUT FOLDABLE TABLE SLIDE



Brand: ALTUS
Material: Aluminum
Finish: Champagne Gold
Depth: 550mm
Height: 146mm
Packing: Per Set, includes 1 pair slides, 1 set square railing, 1 bag accessories & Installation Guide

CODE	TABLE EXTENSION LENGTH	CABINET WIDTH
RHS11-07408	540mm-745mm	600-1200mm



PULL-OUT UPWARD TABLE SLIDE



This system allows to quickly add an extra worktop to your furniture by pulling it out from under the cabinet top.

Brand: ALTUS
Material: Aluminum
Finish: Champagne Gold
Depth: 540mm
Height: 135mm
Packing: Per Set, includes 1 pair slides, 1 set square railing, 1 bag accessories & Installation Guide

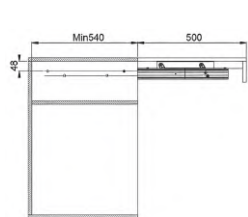

CODE	TABLE EXTENSION LENGTH	CABINET WIDTH
RHS11-07409	460mm	600-1200mm



ISLAND EXPANDABLE TABLE SLIDE-SIDE



Brand: ALTUS
Material: Aluminum
Finish: Champagne Gold
Depth: 600mm
Height: 1420mm
Packing: Per Set, includes 1 pair slides, 1 set Front and Back Aluminum Bar, 1 bag accessories & Installation Manual

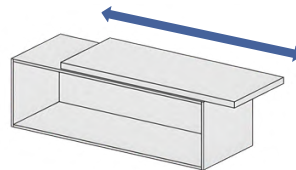

CODE	TABLE EXTENSION LENGTH	CABINET WIDTH
RHS11-07410.A	300mm	600-1800mm



PULL-OUT FOLDABLE TABLE SLIDE



Brand: ALTUS
Material: Aluminum
Finish: Champagne Gold
Depth: 550mm
Height: 146mm
Packing: Per Set, includes 1 pair slides, 1 set square railing, 1 bag accessories & Installation Guide

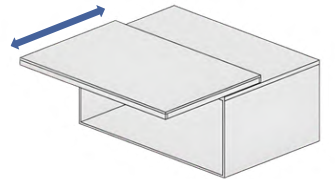

CODE	TABLE EXTENSION LENGTH	CABINET WIDTH
RHS11-07410.B	300mm	600-1800mm

FURNITURE HINGES

LIFT MECHANISMS



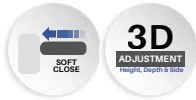

SOFT CLOSE HINGES – PREMIUM QUALITY

with 3D Adjustment (Clip-on Type)

Brand: ALTUS
Material: Steel
Opening Degree: 105°
Hinge Cup Diameter: 35mm
For Door Thickness: 16-24mm
Finish: Nickel Plated
Open Close Test: Passed over 80,000 Cycles
Salt Spray Test: 72hrs
Packing: 2pcs Per Pack, with 2-Hole Plate and Cam, Cover and Screw

3D Adjustment

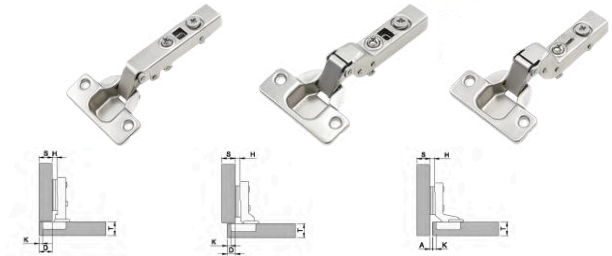

CODE	SIZE
RHS10-01001	Full Overlay
RHS10-01002	Half Overlay
RHS10-01003	Inset



SOFT CLOSE HINGES – MEDIUM QUALITY

with 3D Adjustment (Clip-on Type)

Brand: ALTUS
Material: Steel
Opening Degree: 105°
Hinge Cup Diameter: 35mm
For Door Thickness: 16-24mm
Finish: Nickel Plated
Open Close Test: Passed over 50,000 Cycles
Salt Spray Test: 48hrs
Packing: 2pcs Per Pack, with 2-Hole Plate and Cam, Cover and Screw

3D Adjustment

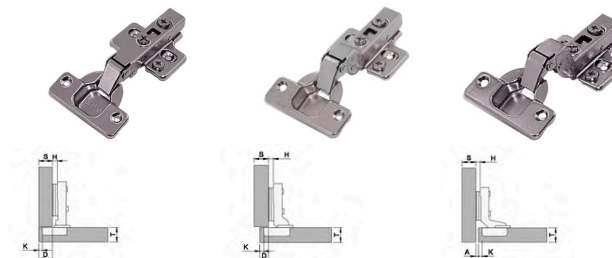

CODE	SIZE
RHS10-02001	Full Overlay
RHS10-02002	Half Overlay
RHS10-02003	Inset



SOFT CLOSE CORNER HINGE

with 3D Adjustment (Clip-on Type)

Brand: ALTUS
Material: Steel
Opening Degree: 105°
Hinge Cup Diameter: 35mm
For Door Thickness: 16-24mm
Finish: Nickel Plated
Open Close Test: Passed over 50,000 Cycles
Salt Spray Test: 24hrs
Packing: 2pcs Per Pack, with 2-Hole Plate and Cam, Cover and Screw

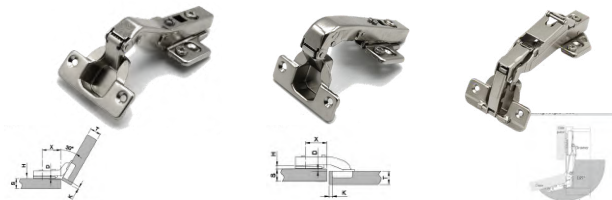

CODE	SIZE
RHS10-02004	45° Corner
RHS10-02005	90° Corner
RHS10-02006	165° Corner



SOFT CLOSE HINGES – MEDIUM QUALITY

with 3D Adjustment (Clip-on Type)

Brand: ALTUS
Material: Steel
Opening Degree: 105°
Hinge Cup Diameter: 35mm
For Door Thickness: 16-20mm
Finish: Nickel Plated
Open Close Test: Passed over 50,000 Cycles
Salt Spray Test: 96hrs
Packing: 2pcs Per Pack, with 4-Hole Plate and Cam, Cover and Screw

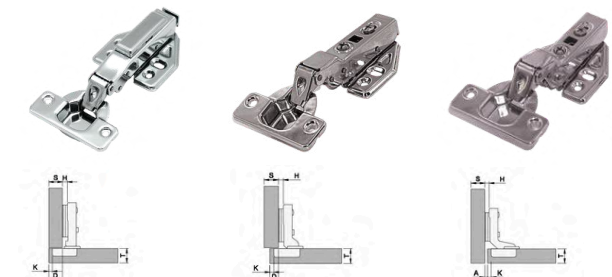

CODE	SIZE
RHS10-03001	Full Overlay
RHS10-03002	Half Overlay
RHS10-03003	Inset



SOFT CLOSE HINGE

Clip-on Type

Brand: ALTUS
Material: Steel
Opening Degree: 105°
Hinge Cup Diameter: 35mm
For Door Thickness: 16-20mm
Finish: Nickel Plated
Open Close Test: Passed over 50,000 Cycles
Salt Spray Test: 24hrs
Packing: 2pcs Per Pack, with 4-Hole Plate and Cam, Cover and Screw

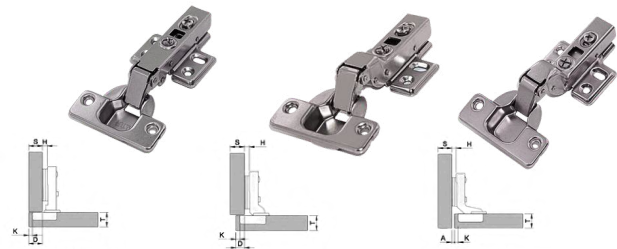

CODE	SIZE
RHS10-04001	Full Overlay
RHS10-04002	Half Overlay
RHS10-04003	Inset



CONCEALED HINGE

Clip-on Type

Brand: ALTUS
Material: Steel
Opening Degree: 105°
Hinge Cup Diameter: 35mm
For Door Thickness: 16-24mm
Finish: Nickel Plated
Open Close Test: Passed over 30,000 Cycles
Salt Spray Test: 24hrs
Packing: 2pcs Per Pack, with 4-Hole Plate and Cam, Cover and Screw

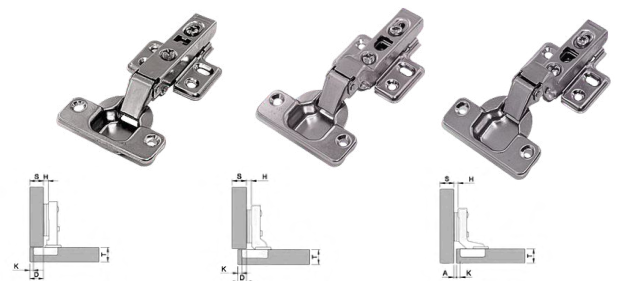

CODE	SIZE
RHS10-05001	Full Overlay
RHS10-05002	Half Overlay
RHS10-05003	Inset



SOFT CLOSE GLASS HINGE

Clip-on Type

Brand: ALTUS
Material: Steel + Plastic
Opening Degree: 105°
Hinge Cup Diameter: 35mm
For Door Thickness: 4-6mm
Finish: Nickel Plated
Open Close Test: Passed over 50,000 Cycles
Salt Spray Test: 96hrs
Packing: 2pcs Per Pack, with 4-Hole Plate and Cam, Cover and Screw

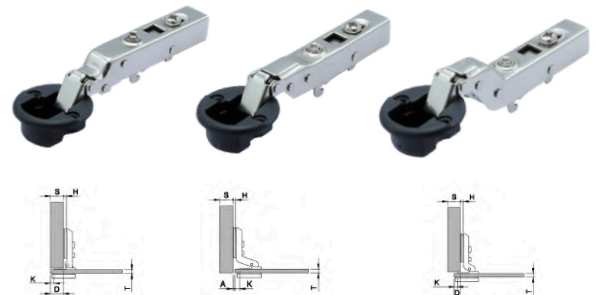

CODE	SIZE
RHS10-06001	Full Overlay
RHS10-06002	Half Overlay
RHS10-06003	Inset



SOFT CLOSE EXCENTRIC HINGES - SS304

with 3D Adjustment (Clip-On Type)

Brand: ALTUS
Material: Steel
Opening Degree: 105°
Hinge Cup Diameter: 35mm
Hinge Cup Depth: 11.7mm
For Door Thickness: 14-20mm
Thickness: 0.7mm to 1.0mm
Finish: Nickel Plated
Open Close Test: Passed over 50,000 Cycles
Salt Spray Test: 48hrs
Packing: 2pcs Per Pack, with 2-Hole Plate and Cam, Cover and Screws

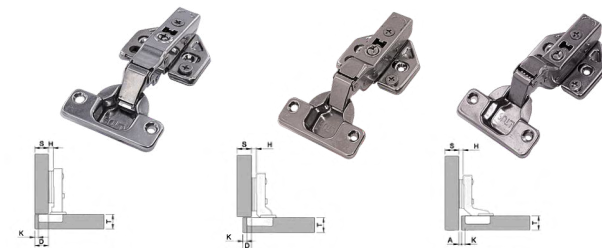

CODE	SIZE
RHS10-07001	Full Overlay
RHS10-07002	Half Overlay
RHS10-07003	Inset



UPWARD LID STAY
Rotatable and easy to adjust



Brand: ALTUS
Material: Aluminum
Finish: Anodized
Size: 247mm x 92mm
Mounting: Left & Right
Load Capacity: 10kgs.
Application: Cabinet Doors
Packing: Per Set, 1 Hydraulic Rod with mounting screws



with Quick Mounting Head

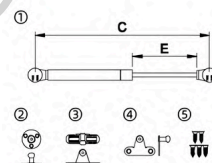

CODE	SIZE	BEARING CAPACITY
RHSDS.20127013.120N	Φ11mm x 11mm(L) x M6	120N



CONCEALED HINGE
Clip-on Type



Brand: ALTUS
Material: Steel
Opening Degree: 105°
Hinge Cup Diameter: 35mm
For Door Thickness: 16-24mm
Finish: Nickel Plated
Open Close Test: Passed over 30,000 Cycles
Salt Spray Test: 24hrs
Packing: 2pcs Per Pack, with 4-Hole Plate and Cam, Cover and Screw

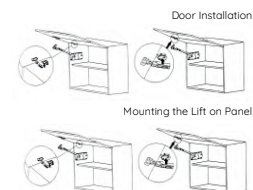
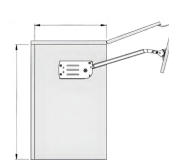

CODE	DOOR HEIGHT	WEIGHT CAPACITY
RHS22-01850	700mm	9.71kg

DRAWER

SYSTEMS





SOFT CLOSE SILENT DRAWER SYSTEM

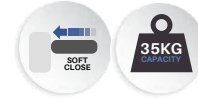

Brand: ALTUS
Series: Magra Line
Material: Aluminum
Finish: Nano Electroplated
Board Thickness: 18mm
Load Capacity: 35kgs
Application: Cabinet Drawers
Packing: Per Set, includes 2pcs SC concealed Slides, 2pcs Side Panel, Front Bracket, 2pcs Rear bracket, 2pcs Decorative Cover, Mounting Screws & Installation Guide



CODE	SIDE PANEL HEIGHT	LENGTH	INTERNAL DRAWER LENGTH
RHSDS.MAG88.400.DGY	88mm	400mm	390mm
RHSDS.MAG88.450.DGY	88mm	450mm	440mm
RHSDS.MAG88.500.DGY	88mm	500mm	490mm
RHSDS.MAG88.550.DGY	88mm	550mm	540mm
RHSDS.MAG120.400.DGY	120mm	400mm	390mm
RHSDS.MAG120.450.DGY	120mm	450mm	440mm
RHSDS.MAG120.500.DGY	120mm	500mm	490mm
RHSDS.MAG120.550.DGY	120mm	550mm	540mm
RHSDS.MAG171.400.DGY	171mm	400mm	390mm
RHSDS.MAG171.450.DGY	171mm	450mm	440mm
RHSDS.MAG171.500.DGY	171mm	500mm	490mm
RHSDS.MAG171.550.DGY	171mm	550mm	540mm
RHSDS.MAG203.400.DGY	203mm	400mm	390mm
RHSDS.MAG203.450.DGY	203mm	450mm	440mm
RHSDS.MAG203.500.DGY	203mm	500mm	490mm
RHSDS.MAG203.550.DGY	203mm	550mm	540mm



SOFT CLOSE SILENT DRAWER SYSTEM



Brand: ALTUS
Series: Magra Line
Material: Aluminum
Finish: Nano Electroplated - Shiny White
Board Thickness: 18mm
Load Capacity: 35kgs
Application: Cabinet Drawers
Packing: Per Set, includes 2pcs SC concealed slides, 2pcs Front bracket, 2pcs Side panel, 2pcs Rear bracket, 2pcs Decorative Cover, Mounting Screws & Installation Guide



CODE	SIDE PANEL HEIGHT	LENGTH	INTERNAL DRAWER LENGTH
RHSDS.MAG88.450.WHT	88mm	450mm	440mm
RHSDS.MAG88.500.WHT	88mm	500mm	490mm
RHSDS.MAG120.500.WHT	120mm	500mm	490mm
RHSDS.MAG171.500.WHT	171mm	500mm	490mm
RHSDS.MAG203.450.WHT	203mm	450mm	440mm
RHSDS.MAG203.500.WHT	203mm	500mm	490mm

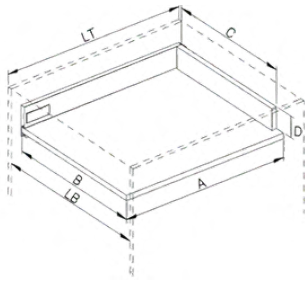

- A Bottom Panel Length
- B Bottom Panel Width
- C Back Panel Width
- D Back Panel Height
- Side Board Height
- Bottom Panel Thickness
- LB Inside Cabinet Width
- LT Min. Interior Cabinet Depth Depending on the Runner Used

Runner length-20
 LB-19
 LB-42
 63/101/148/202
 90/128/175/240
 16/18

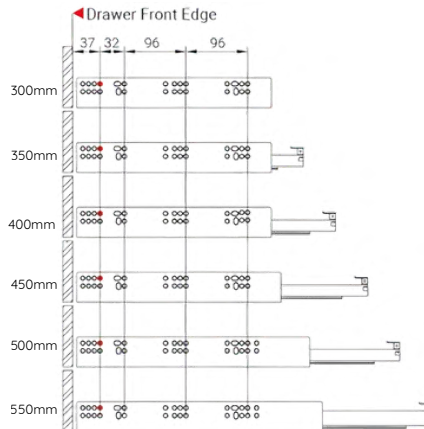

Drawer Adjustment

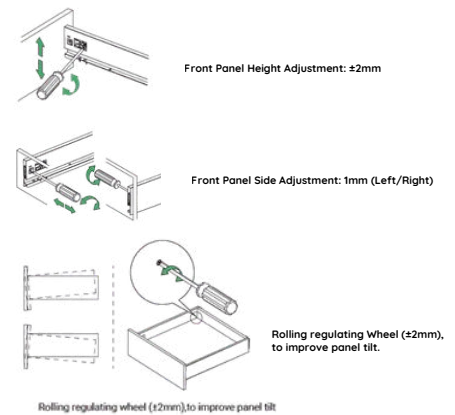

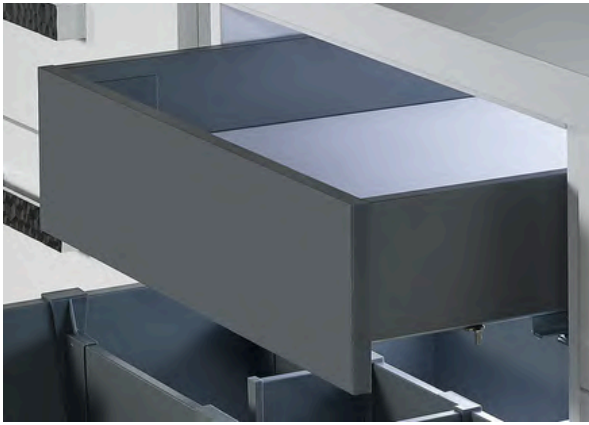

STANDARD INNERBOX SYSTEM

with Soft Closing Mechanism

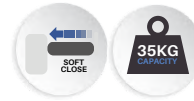

Brand: ALTUS
Series: Magra Line
Material: Aluminum
Finish: Nano Electroplated - Iron Grey
Board Thickness: 18mm
Load Capacity: 35kgs
Application: Cabinet Drawers
Packing: Per Set, includes 2pcs SC concealed slides, 2pcs Side Panel, 1pc Front Panel, 2pcs Front bracket, 2pcs Rear bracket, 2pcs Decorative Cover, Mounting Screws & Installation Guide

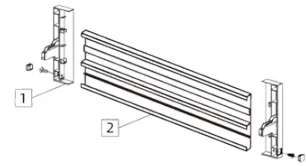

CODE	SIDE PANEL HEIGHT	LENGTH	INTERNAL DRAWER LENGTH
RHSDS.MAGIN88.500	88mm	20"/500mm	490mm



SOFT CLOSING STARBOX

with Aluminum Railing System



Brand: ALTUS
Series: Sentra Line
Material: Aluminum
Finish: Nano Electroplated - Iron Grey
Board Thickness: 16mm (can also be used for 18mm)
Load Capacity: 35kgs
Application: Cabinet Drawers
Packing: Per Set, includes 2pcs Soft Close Concealed Slides, 2pcs Side Panel, 2pcs Front Bracket, 2pcs Aluminum Square Railing, 2pcs Rear bracket, 2pcs Decorative Cover, Mounting Screws & Installation Guide

CODE	SIDE PANEL HEIGHT	LENGTH	INTERNAL DRAWER LENGTH
RHSDS.SEN215.500.GRY	88mm	20"/500mm	490mm

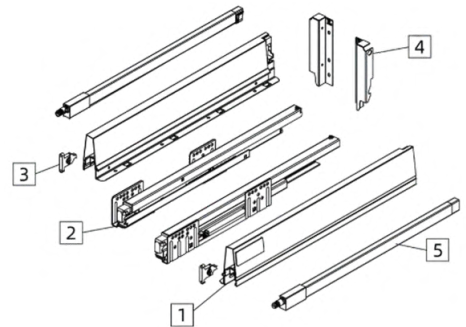
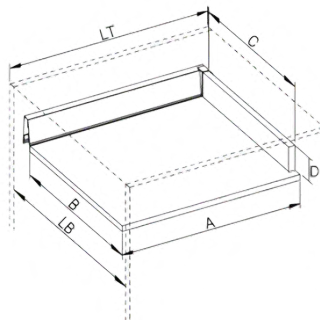
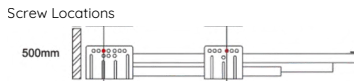

INNER DRAWER SYSTEM

with Square Railing System



Brand: ALTUS
Series: Sentra Line
Material: Aluminum
Finish: Nano Electroplated - Iron Grey
Board Thickness: 18mm
Load Capacity: 30kgs
Application: Cabinet Drawers
Packing: Per Set, includes 2pcs SC concealed slides, 2pcs Side Panel, 1pc Front Panel, 2pcs Front bracket, 1pc Draw Rod, 2pcs Aluminum Square Railing, 2pcs Rear bracket, 2pcs Decorative Cover, Mounting Screws & Installation Guide

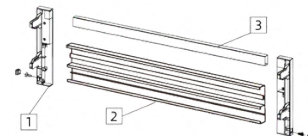

CODE	SIDE PANEL HEIGHT	LENGTH	INTERNAL DRAWER LENGTH
RHSDS.SENIN171.500G	88mm	20"/500mm	490mm



*Dish Rack not included.

European Style
MULTI-PURPOSE DRAWER
with Soft Closing Mechanism



- Brand:** ALTUS
Series: Rio Line
Material: Steel
Finish: Nano Electroplated
Color: Iron Grey
Cabinet Depth: 500mm
Load Capacity: 25kgs
Application: Cabinet Drawers with 1pair SC Concealed Slides,
 2pcs Door Connector,
 2pcs Connector Deckboard,
 2pcs Slide Lock, 2pcs Slide Connector,
 4pcs Wall Plug, Mounting Screws & Installation Guide

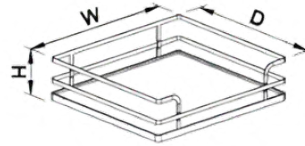

CODE	SIZE	CARCASS WIDTH
RHSDS.RIO134.600	529mm (W) x 451.5mm (D) x 150mm (H)	600mm
RHSDS.RIO134.700	629mm (W) x 451.5mm (D) x 150mm (H)	700mm
RHSDS.RIO134.800	729mm (W) x 451.5mm (D) x 150mm (H)	800mm
RHSDS.RIO134.900	829mm (W) x 451.5mm (D) x 150mm (H)	900mm

SLIM DOUBLE-WALL DRAWER SYSTEM
PUSH-OPEN SOFT CLOSE GUIDES

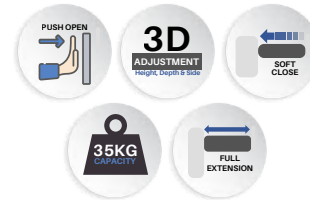

- Brand:** ALTUS
Finish: Nano Electroplated
Color: Iron Grey
Board Thickness: 18mm
Load Capacity: 35kgs
Application: Cabinet Drawers
Packing: Per Set, includes 2pcs SC concealed Slides
 2pcs Side Panel, Front Bracket, Synchro Rod
 2pcs Rear bracket, 2pcs Decorative Cover
 Mounting Screws & Installation Guide

Stabilizer Rod: 900mm-1200mm Drawer Width

Adjustment: 3D + Tilt Adjustment

- Left and Right (+1.2mm)
- Up and down (0-3mm)
- Back and front (0-5mm)
- Tilt (-1.5mm - 4mm)

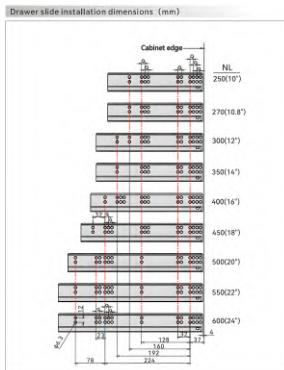
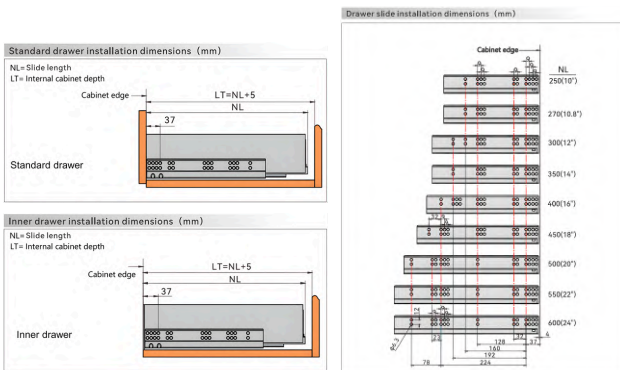

CODE	SIDE PANEL HEIGHT	LENGTH	INTERNAL DRAWER LENGTH
RHSDS.CAR95.450	95mm	450mm	440mm
RHSDS.CAR95.500	95mm	500mm	490mm
RHSDS.CAR95.550	95mm	550mm	540mm
RHSDS.CAR133.450	133mm	450mm	440mm
RHSDS.CAR133.500	133mm	500mm	490mm
RHSDS.CAR133.550	133mm	550mm	540mm
RHSDS.CAR180.450	180mm	450mm	440mm
RHSDS.CAR180.500	180mm	500mm	490mm
RHSDS.CAR180.550	180mm	550mm	540mm

Drawer Adjustment Demonstration

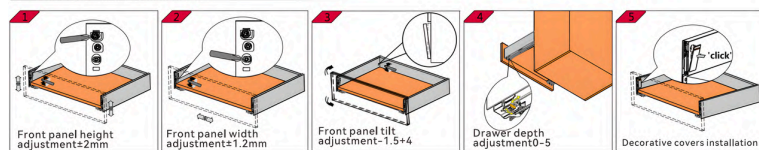



**KITCHEN
ACCESSORIES**
& STORAGE SOLUTIONS





ALL PURPOSE PULL-OUT BASKET

with Soft Closing Mechanism



Brand: ALTUS
Material: Steel
Finish: Chrome Plated
Application: Bottom Mounted
Packing: Per Set, includes 4pcs Fixing Plate, 4pcs Plastic Fixing Plate, 1pair Concealed Slides, Set of Mounting Screws & Installation Guide

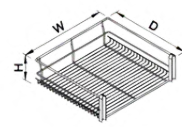

CODE	SIZE	CARCASS WIDTH
RHS13-01500	393mm(W) x 440mm(D) x 140mm(H)	500mm
RHS13-01600	493mm(W) x 440mm(D) x 140mm(H)	600mm
RHS13-01800	693mm(W) x 440mm(D) x 140mm(H)	800mm
RHS13-01900	793mm(W) x 440mm(D) x 140mm(H)	900mm



MULTI-PURPOSE PULL-OUT BASKET (INTERNAL)

with Soft Close Concealed Drawer Guides and Tray



Brand: ALTUS
Material: Basket: Steel/Tray: Plastic
Finish: Chrome Plated
Loading Capacity: 30kgs. (drawer slides)
Application: Bottom Mounted
Packing: Per Set, includes 1pc Basket, 1pair Concealed SC Slides, 1pc Tray, Set of Mounting Screws & Installation Guide

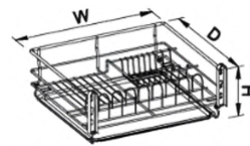

CODE	SIZE	CARCASS WIDTH
RHS13-02600	495mm (W) x 450mm (D) x 170mm (H)	600mm
RHS13-02700	595mm (W) x 450mm (D) x 170mm (H)	700mm
RHS13-02800	695mm (W) x 450mm (D) x 170mm (H)	800mm
RHS13-02900	795mm (W) x 450mm (D) x 170mm (H)	900mm



PULLOUT WIRE BASKET (3-LAYER)

Bottom Mount-with Soft Close Ball Bearing Slides



Brand: ALTUS
Material: Steel
Finish: Chrome Plated
Packing: Per Set, includes 1pair SC Concealed Slides, 2pcs Door Connector, 2pcs Connector Deckboard, 2pcs Slide Lock, 2pcs Slide Connector, 4pcs Wall Plug, Mounting Screws & Installation Guide

CODE	SIZE
RHS13-03400	345mm (W) x 475mm (D) x 455mm (H)



SIDE PANTRY

with Soft close ball bearing slides



Brand: ALTUS
Material: Steel
Finish: Chrome Plated
Cabinet Depth: 500mm
Application: Side Mounted
Packing: Per Set, includes 1pair Right Side Mounted Concealed Slides, 2pcs Fixing Part for Door, 4pcs Fixing Plate, 20pcs ST3.5x16 Screws, 4pcs M5x6 Screws, 2pcs M5x16, 4pcs M5x12 Screws & Installation Manual

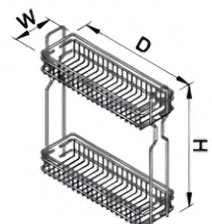

CODE	SIZE	CARCASS WIDTH
RHS13-04150SDR	95mm (W) x 450mm (D) x 500mm (H)	150mm
RHS13-04150SDL	95mm (W) x 450mm (D) x 500mm (H)	150mm



SIDE PANTRY
with Soft close ball bearing slides



Brand: ALTUS
Material: Steel
Finish: Chrome Plated
Cabinet Depth: 500mm
Application: Side Mounted
Packing: Per Set, includes 1pair Soft Close Side Mounted Slides, 4pcs Plastic Parts, 14pcs ST4x16 Screws (Round Head), 4pcs M4x6 Screws, 2pcs M5x16 & Installation Manual

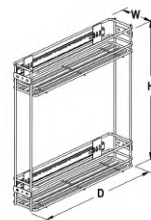

CODE	SIZE	CARCASS WIDTH
RHS13-05150SD	100mm (W) x 465mm (D) x 480mm (H)	150mm
RHS13-05200SD	145mm (W) x 465mm (D) x 480mm (H)	200mm



FRONT PANEL FITTINGS
For All Purpose Basket

Brand: ALTUS
Material: Steel
Finish: Chrome Plated
Application: Bottom Mounted
Packing: Per Pair, with screws

CODE	SIZE
RHSAC-24291	125mm x 16mm



UNDER SINK DRAWER BASKET
With Soft Closing Mechanism



Brand: ALTUS
Material: Steel
Finish: Chrome Plated
Application: Bottom Mounted
Packing: Per Set, includes 1pair SC Concealed Slides, 2pcs Door Connector, 2pcs Connector Deckboard, 2pcs Slide Lock, 2pcs Slide Connector, 4pcs Wall Plug, Mounting Screws & Installation Guide

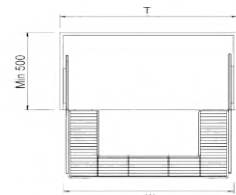

CODE	SIZE	CARCASS WIDTH
RHS13-08900	865mm (W) x 460mm (D) x 180mm (H)	900mm



2 LAYER ALUMINUM DISH RACK
with Drip Tray

Brand: ALTUS
Material: 201 Stainless Steel
Finish: Rack: Chrome Plated/Tray: Transparent
Board Thickness: 18mm Side Panel
Packing: Per Set, includes 2pcs Rack, 2pcs Drip Tray, 2pcs Holder (A), 2pcs Holder (B), 2pcs Aluminum Tube (Front & Back), 8pcs ST5x16 Screws, 5pcs ST3x10 Screws & Installation Manual

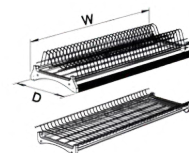

CODE	SIZE	CARCASS WIDTH
RHS14-01500	468mm(W) x 280mm(D) x 126mm(H)	500mm
RHS14-01600	568mm(W) x 280mm(D) x 126mm(H)	600mm
RHS14-01700	668mm(W) x 280mm(D) x 126mm(H)	700mm
RHS14-01800	768mm(W) x 280mm(D) x 126mm(H)	800mm
RHS14-01900	868mm(W) x 280mm(D) x 126mm(H)	900mm



STAINLESS STEEL DISH RACK

Two layer dish rack with stainless steel water holder

Brand: ALTUS
Material: 201 Stainless Steel
Finish: Nuomenal
Pan Size: 522mm(W) x 234mm(D) x 40mm(H)
Tray Size: 596mm(W) x 238mm(D)
Packing: Per Set, includes 1pc Plate & Dish Holder, 1pc Drip Pan, 1pc Tray & Installation Manual

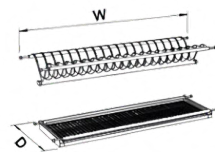

CODE	SIZE	CARCASS WIDTH
RHS14-02600	280mm(D) x 564mm(W) x 95H(65)mm	600mm
RHS14-02700	280mm(D) x 664mm(W) x 95H(65)mm	700mm
RHS14-02800	280mm(D) x 764mm(W) x 95H(65)mm	800mm
RHS14-02900	280mm(D) x 864mm(W) x 95H(65)mm	900mm



QUARTER ROUND CAROUSEL

Brand: ALTUS
Material: Steel
Finish: Chrome Plated
Door Opening: 900mm
Load Capacity: 10kgs.
Packing: Per Set, includes 2pcs Quarter Round Basket Round Bar Post, Fittings & Mounting Screws and Installation Manual

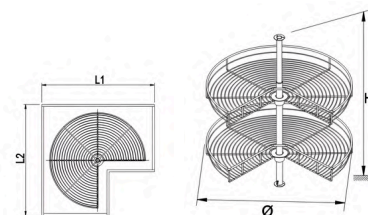

CODE	SIZE	CARCASS WIDTH
RHS15-01700	Φ600mm x 600-750mm (H)	700mm
RHS15-01800	Φ710mm x 600-750mm (H)	800mm
RHS15-01900	Φ800mm x 600-750mm (H)	900mm



HALF ROUND CAROUSEL

180 revolving basket

Brand: ALTUS
Material: Steel
Finish: Chrome Plated
Cabinet Width: 800mm
Load Capacity: 10kgs.
Packing: Per Set, includes 2pcs Half Round Baskets, Round Bar Post Fittings & Mounting Screws and Installation Manual

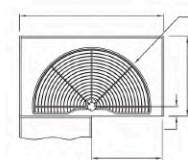

CODE	SIZE	CARCASS WIDTH
RHS15-02800	Ø740mm/D 410mm /H 600-750mm	900mm



SOFT PULL DOWN KITCHEN CABINET

With Soft Close Mechanism

Brand: ALTUS
Material: SS 201
Finish: Nuomenal
Cabinet Width: 600mm - 900mm
Load Capacity: 18kgs.
Cabinet Depth: 400mm
Packing: Per Set, includes Lift System, Screws and Installation Manual

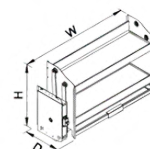

CODE	SIZE	CARCASS WIDTH
RHS16-01600	340mm (D) x 564mm (W) x 600mm (H)	600mm
RHS16-01700	340mm (D) x 664mm (W) x 600mm (H)	700mm
RHS16-01800	340mm (D) x 764mm (W) x 600mm (H)	800mm
RHS16-01900	340mm (D) x 864mm (W) x 600mm (H)	900mm



SOFT PULLDOWN KITCHEN GLASS BASKET

With Weight Regulator



- Brand:** ALTUS HARDWARE
- Material:** Steel + Glass
- Finish:** Iron Grey
- Cabinet Width:** 600mm
- Feature:** Load Grading Adjustment
- Packing:** Per Set, includes Lift System, Mounting Screws and Installation Manual

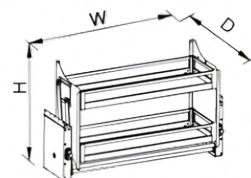

CODE	SIZE	CABINET DEPTH
RHS16-02600	562mm(W) x 255mm(D) x 545mm(H)	400mm



SOFT PULLDOWN KITCHEN LIFT SYSTEM

with Dish rack and Weight Regulator



- Brand:** ALTUS HARDWARE
- Material:** Steel
- Finish:** Chrome Plated Iron Grey and Beige
- Cabinet Width:** 600mm, 800mm
- Feature:** Load Grading Adjustment
- Packing:** Per Set, includes Lift System, with Removable Tray, Mounting Screws & Installation Manual

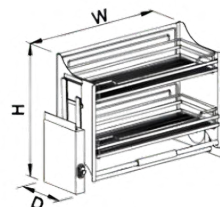

CODE	SIZE	COLOR
RHS16-03600	560mm(W) x 260mm(D) x 545mm(H)	Beige
RHS16-03800	760mm(W) x 260mm(D) x 545mm(H)	Grey



SMALL LARDER UNIT

With Soft Close Mechanism



- Brand:** ALTUS HARDWARE
- Material:** Steel
- Finish:** Chrome Plated
- Cabinet Width:** 450mm, 600mm
- Cabinet Height:** 530mm - 860mm
- Capacity:** 18kgs.
- Packing:** Per Set, includes 2pcs Big Basket, 2pcs Small Basket, 1pc Base Plate with 1pair Bottom Mounted Concealed Drawer Guides, 1pc Small Aircraft, 2pcs Connection Bar, 2pcs Door Connecting Strips, 1pc U-Groove, 1pcs Adjustable Bracket/Frame, 2pcs Connection Block, 16pcs Self Tapping Screw, 6pcs M4x24 Screw, 2pcs M5x8 Bolt, & 2pcs M6x16 Bolt and Installation Manual

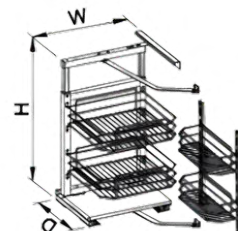

CODE	SIZE	CARCASS WIDTH
RHS17-01450	385mm(W) x 530mm(D) x 530-860mm(H)	450mm
RHS17-01600	530mm(W) x 530mm(D) x 530-860mm(H)	600mm



PULL OUT PANTRY (HEAVY DUTY)
with Soft Close Mechanism



Brand: ALTUS
Material: Steel
Finish: Chrome Plated
Cabinet Width: 400mm
Capacity: 50kgs.
Layers: 4 Layers, 5 Layers & 6 Layers
Packing: Per Set, includes includes Baskets, Structural support, Connectors, Mounting Screws and Installation Manual

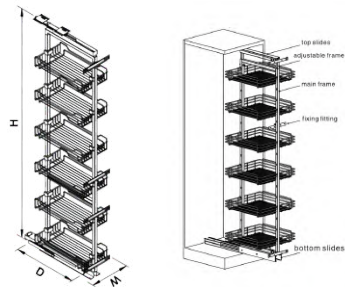

CODE	SIZE	LAYERS
RHS18-01400.4	345mm(W) x 500mm(D) x 1220-1520mm(H)	4 layers
RHS18-01400.5	345mm(W) x 500mm(D) x 1570-1870mm(H)	5 layers
RHS18-01400.6	345mm(W) x 500mm(D) x 1920-2220mm(H)	6 layers



Soft Close
LARDER UNIT WITH INTERNAL EXTENSION SET



Brand: ALTUS
Material: Steel
Finish: Chrome Plated
Cabinet Width: 400mm
Capacity: 50kgs.
Layers: 4 Layers, 5 Layers & 6 Layers
Packing: Per Set, includes includes Baskets, Structural support, Connectors, Mounting Screws and Installation Manual

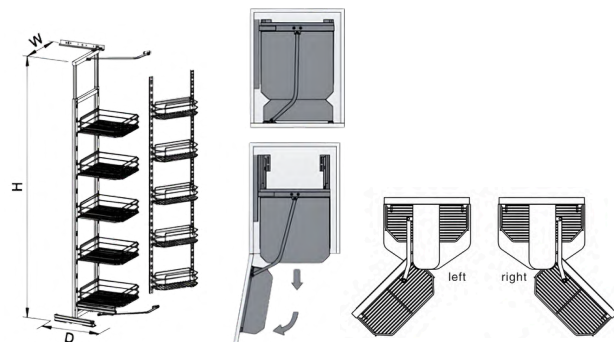

CODE	SIZE	LAYERS
RHS19-01450.4	385mm(W) x 530mm(D) x 1320-1620mm(H)	4 layers
RHS19-01450.5	385mm(W) x 530mm(D) x 1620-1920mm(H)	5 layers
RHS19-01450.6	385mm(W) x 530mm(D) x 1920-2220mm(H)	6 layers



MAGIC CORNER BASKET
with Soft close mechanism & Anti-Slip Mat



Brand: ALTUS
Material: Steel and Board
Finish: Iron Grey
Cabinet Width: 900mm
Opening: Left/Right
Layers: Per Set, 4pcs Basket, Frame, Soft Close Drawer Guides
Packing: Powder Coated Steel, Fittings, Mounting Screws & Installation Manual

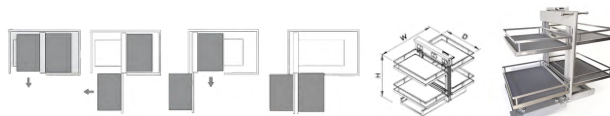

CODE	SIZE	
RHS20.01900.L	719mm(W) x 515mm(D) x 600mm(H)	Left
RHS20.01900.R	719mm(W) x 515mm(D) x 600mm(H)	Right



PLATES AND BOWL BASKET WITH CUTLERY TRAYS
with soft close mechanism



Brand: ALTUS
Series: Dana
Material: Aluminum and Tempered Glass
Finish: Grey & Silver
Glass Thck: 5mm
Function: Kitchen Organizer
Packing: Per Set, includes Bowl and Plate Holder, 3sets Cutlery Tray With Mounting Screws & Installation Manual

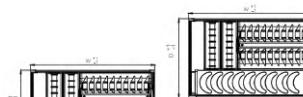

CODE	SIZE	CABINET WIDTH
RHSDS.DANA.93281	764mm(W) x 476mm(D) x 172mm(H)	800mm
RHSDS.DANA.93291	864mm(W) x 476mm(D) x 172mm(H)	900mm



PLATES AND BOWL BASKET WITH CUTLERY TRAY
with soft closing mechanism & ANTI-SLIP MAT



Brand: ALTUS
Series: Eva
Material: Anti-Rust Aluminum Frame
Finish: Woodgrain
Function: Kitchen Organizer
Packing: Per Set, includes Bowl and Plate Holder, 2pcs Cutlery Tray With Mounting Screws & Installation Manual

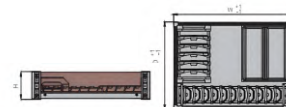

CODE	SIZE	CABINET WIDTH
RHSDS.EVA.94280	764mm(W) x 476mm(D) x 175mm(H)	800mm
RHSDS.EVA.94290	864mm(W) x 476mm(D) x 175mm(H)	900mm



MULTI-PURPOSE BASKET
Three-Sides Panel Base Panel with Anti-Slip Mat & Soft Closing Mechanism



Brand: ALTUS
Series: Eva
Material: Anti-Rust Aluminum Frame
Finish: Woodgrain
Function: For Plates, Pots and Pans
Packing: Per Set, includes Mounting Screws & Installation Manual

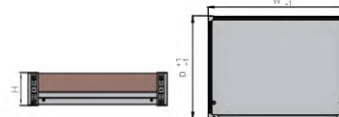

CODE	SIZE	CABINET WIDTH
RHSDS.EVA.94180	729mm(W) x 467mm(D) x 149mm(H)	800mm
RHSDS.EVA.94190	829mm(W) x 467mm(D) x 149mm(H)	900mm



SEASONING BASKET

with Soft Closing Mechanism & Anti-Slip Mat



Brand: ALTUS
Series: Eva
Material: Anti-Rust Aluminum Frame
Finish: Woodgrain
Function: For Plates, Pots and Pans
Packing: Per Set, includes with Cooking Utensils Holder, Chopping Board, Knives Holder, Mounting Screws & Installation Manual

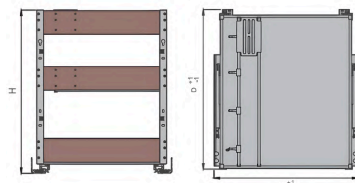

CODE	SIZE
RHSDS.EVA.94335	314mm(W) x 460mm(D) x 477mm(H)



SOFT PULL DOWN BASKET

with Weight Regulator & Anti-Slip Mat



Brand: ALTUS
Series: Eva - Woodgrain
Material: Anti-Rust Aluminum
Finish: Iron Grey & Woodgrain
Feature: Load Grading Adjustment & Soft Close
Function: Kitchen Organizer
Packing: Per Set, with Mounting Screws & Installation Manual

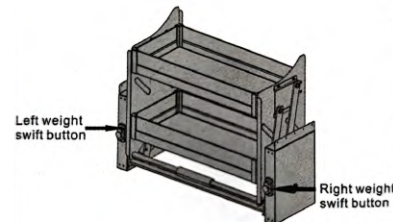

CODE	SIZE	CABINET WIDTH
RHSDS.EVA.71060	564mm(W) x 269mm(D) x 555mm(H)	600mm
RHSDS.EVA.71080	764mm(W) x 269mm(D) x 555mm(H)	800mm



MAGIC CORNER (LEFT/RIGHT)

with Soft closing Mechanism & Anti-Slip Mat



Brand: ALTUS
Series: Eva
Material: Anti-Rust Aluminum Frame
Finish: Woodgrain
Application: Left or Right
Packing: Per Set, with Mounting Screws & Installation Manual

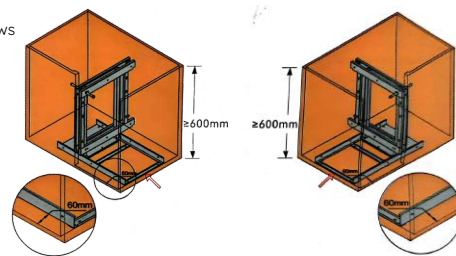

CODE	SIZE	CABINET WIDTH
RHSDS.EVA.81001	650mm(W) x 480mm(D) x 560mm(H)	800mm



LARDER UNIT
with Anti-Slip Mat & Soft Closing Mechanism



Brand: ALTUS
Series: Eva
Material: Anti-Rust Aluminum Frame
Finish: Woodgrain
Function: For Plates, Pots and Pans
Packing: Per Set, includes 12pcs Baskets, Structural Support, Connectors, Mounting Screws and Installation Manual

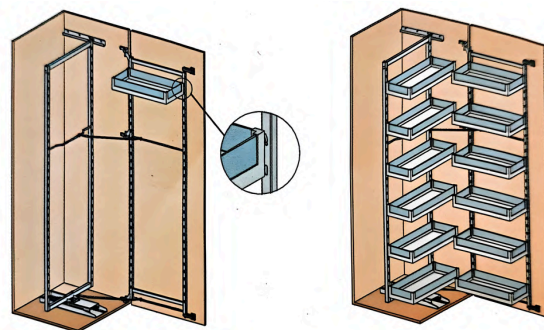

CODE	SIZE	CABINET WIDTH
RHSDS.EVA.81056	480mm(W) x 403mm(D) x 1765mm(H)	500mm



PULL OUT PANTRY
with Anti-Slip Mat & Soft Closing Mechanism



Brand: ALTUS
Series: Eva
Material: Anti-Rust Aluminum
Finish: Woodgrain
Cabinet Height: 1800mm - 2100mm
Layers: 6 Layer
Capacity: 60kgs.
Packing: Per Set, includes 12pcs Baskets, Structural Support, Connectors, Mounting Screws & Installation Guide

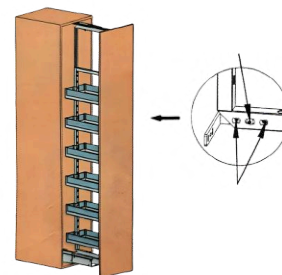

CODE	SIZE	CABINET WIDTH
RHSDS.EVA.81146	350mm(W) x 480mm(D)	400mm



ELECTRIC LIFT

KITCHEN STORAGE TECHNOLOGY



NEW

ELECTRIC LIFT KITCHEN STORAGE - SPICE RACK



Brand: ALTUS
Material: Premium aviation-grade aluminum construction
Installation Type: Cabinet-Integrated
Switch Type: Touch Switch
Packing: Per Set, includes Screws & Installation Guide

FEATURES

- Effortless access to upper cabinet storage.
- Quiet operation -45 dB.
- Intelligent anti-collision system stops movement on contact.
- Controlled 8-second descent time for safety and stability.
- 30,000 Lifting cycles
- Smart Sensor LED Lights (when cabinet is lowered, the lights automatically turn on; when the pull down cabinet shelf is raised, the lights turn off).
- Easy Installation



Touch Switch
Touch Switch to Control the Smart Electric Lifting System Up/Down.



Smart Sensor LED Light
The Electric Lifting System comes with the smart sensor LED light that make it easier for you to find what you need in the dark.



Move Freely Box
The storage box in the Smart Electric Lifting Basket can be moved freely.



Anti-Collision Designed
Automatically stops when it encounters an obstacle.

CODE	SIZE	CABINET WIDTH
RHS24-01600	564mm (W) x 256mm (D) x 664mm (H)	600mm
RHS24-01800	764mm (W) x 256mm (D) x 664mm (H)	800mm



NEW

ELECTRIC LIFT KITCHEN STORAGE 2 TIER



Brand: ALTUS
Material: Premium aviation-grade aluminum construction
Installation Type: Cabinet-Integrated
Switch Type: Touch Switch
Packing: Per Set, includes Screws & Installation Guide



CODE	SIZE	CABINET WIDTH
RHS24-02600	564mm (W) x 256mm (D) x 664mm (H)	600mm
RHS24-02800	764mm (W) x 256mm (D) x 664mm (H)	800mm



NEW

ELECTRIC LIFT KITCHEN STORAGE 2 TIER



Brand: ALTUS
Material: Premium aviation-grade aluminum construction
Installation Type: Cabinet-Integrated
Switch Type: Touch Switch
Packing: Per Set, includes Screws & Installation Guide



CODE	SIZE	CABINET WIDTH
RHS24-03600	564mm (W) x 256mm (D) x 664mm (H)	600mm
RHS24-03800	764mm (W) x 256mm (D) x 664mm (H)	800mm



CUTLERY TRAYS
& DRAWER INSERTS



STAINLESS STEEL CUTLERY TRAY

103 Type knife & fork plate

Brand: ALTUS
Material: Stainless Steel 201 + Plastic
Finish: Gray
Packing: Per Set, includes 1pc Cutlery Frame, 1pc Tray Insert (Small) & 1pc Tray Insert (Big)

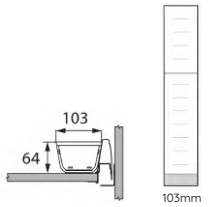

CODE	SIZE
RHS19-01500	103mm(W) x 473mm(D) x 64mm(H)



STAINLESS STEEL CUTLERY TRAY

104 type knife & fork plate

Brand: ALTUS
Material: Stainless Steel 201 + Plastic Guard
Finish: Gray
Packing: Per Set, 1pc Cutlery Frame, 3pcs Tray Insert (Small) & 3pcs Tray Insert (Big)

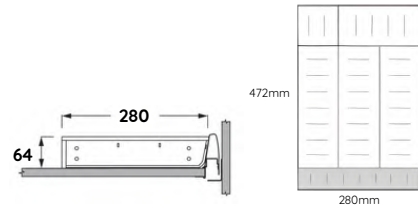

CODE	SIZE
RHS19-02500	280mm(W) x 472mm(D) x 64mm(H)



STAINLESS STEEL CUTLERY TRAY

108 type knife & fork plate

Brand: ALTUS
Material: Stainless Steel 201 + Plastic Guard
Finish: Gray
Packing: Per Set, 1pc Cutlery Frame, 1pc Tray Insert (Small), 1pc Tray Insert (Big) & 2pcs fittings

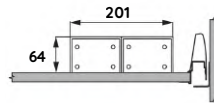

CODE	SIZE
RHS19-03500	201mm(W) x 475mm(D) x 64mm(H)



STAINLESS STEEL CUTLERY TRAY

109 type knife & fork plate

Brand: ALTUS
Material: Stainless Steel 201 + Plastic Guard
Finish: Gray
Packing: Per Set, pc Cutlery Frame, 3pcs Tray Insert (Small) & 1pc Tray Insert (Big)

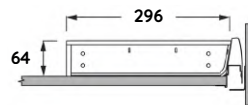

CODE	SIZE
RHS19-04500	296mm (W) x 475mm (D) x 64mm (H)



STAINLESS STEEL CUTLERY TRAY

108 type knife & fork plate

Brand: ALTUS
Material: Stainless Steel 201 + Plastic Guard
Finish: Gray
Packing: Per Set, includes 1pc Cutlery Frame, 3pcs Tray Insert (Small) & 3pcs Tray Insert (Big) & 1pc fitting

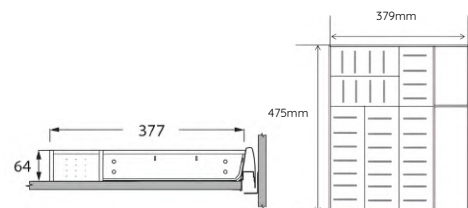

CODE	SIZE
RHS19-05500	379mm (W) x 475mm (D) x 64mm (H)



STAINLESS STEEL CUTLERY FRAME

Brand: ALTUS
Material: Stainless Steel 201 + Plastic
Finish: Gray
Packing: Per Set

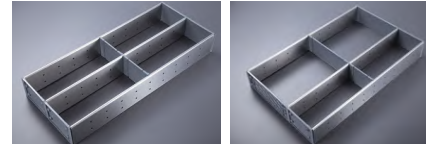

CODE	SIZE
RHS19-01500	103mm(W) x 473mm(D) x 64mm(H)
RHS19-02500	204mm (W) x 473mm (D) x 64mm (H)
RHS19-03500	292mm(W) x 472mm(D) x 64mm(H)



STAINLESS STEEL CUTLERY TRAY

Brand: ALTUS
Material: Stainless Steel 201
Finish: Gray
Function: Knife & Fork/Kitchen Organizer
Packing: Per Piece

CODE	SIZE
RHS19-09BIG	264mm (W) x 88mm (D) x 60mm (H)
RHS19-09SMALL	176mm (W) x 88mm (D) x 60mm (H)



NEW

BAMBOO CUTLERY TRAY - EXTENDEDABLE

Slide-out expandable section allows for more silverware storage.

Brand: ALTUS
Material: Bamboo
Application: Great for kitchen, office, bathroom, craft drawers

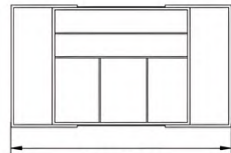

W580~790

CODE	SIZE
RHS19-0941210	580-790mm (W) x 464mm (D) x 53mm (H)



NEW

BAMBOO CUTLERY TRAY - EXTENDEDABLE

Slide-out expandable section allows for more silverware storage.

Brand: ALTUS
Material: Bamboo
Application: Great for kitchen, office, bathroom, craft drawers



265

CODE	SIZE
RHS19-0941213	265mm (W) x 472mm (D) x 53mm (H)



HORIZONTAL DIVIDER

Brand: ALTUS
Material: Aluminum Alloy + Plastic
Finish: Iron Grey
Packing: Per Piece

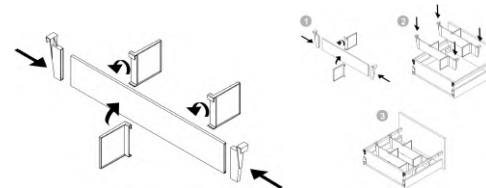

CODE	SIZE
RHSAC-04967-527	527mm
RHSAC-04967-827	827mm

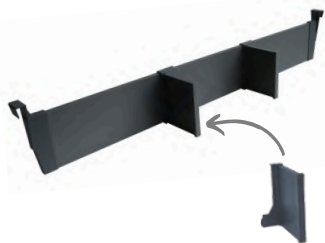

VERTICAL DIVIDER

for Drawer System, 946 type; straight shape, must use with 04945 item

Brand: ALTUS
Material: Aluminum Alloy + Plastic
Finish: Iron Grey
Packing: Per Piece

CODE	SIZE
RHSAC-04946	90mm (H)



ABS CUTLERY TRAY (450)

Brand: ALTUS
Material: ABS (Acrylonitrile Butadiene Styrene) Plastic
Finish: Glossy Gray
Inner Size: 395mm (W) x 318mm (D) x 45mm (H)
Outer Size: 472mm (W) x 369mm (D) x 46mm (H)
Packing: Per Piece

CODE	SIZE
RHS19-41115.450	472mm(W) x 369mm(D) x 46mm(H)



ABS CUTLERY TRAY (600)

Brand: ALTUS
Material: ABS (Acrylonitrile Butadiene Styrene) Plastic
Finish: Glossy Gray
Inner Size: 464mm (W) x 392mm (D) x 45mm (H)
Outer Size: 519mm (W) x 473mm (D) x 46mm (H)
Packing: Per Piece

CODE	SIZE
RHS19-41115.603	519mm(W) x 473mm(D) x 46mm(H)



ABS CUTLERY TRAY

Brand: ALTUS
Material: ABS (Acrylonitrile Butadiene Styrene) Plastic
Finish: Glossy Gray
Cabinet Width: 600mm
Packing: Per Piece

CODE	SIZE
RHS19-41125.600	525mm(W) x 478mm(D) x 60mm(H)



ABS CUTLERY TRAY

Brand: ALTUS
Material: ABS (Acrylonitrile Butadiene Styrene) Plastic
Finish: Glossy Gray
Cabinet Width: 800mm
Packing: Per Piece

CODE	SIZE
RHS19-41125.800	764mm(W) x 460mm(D) x 60mm(H)



EXPANDABLE DISH RACK

Brand: ALTUS
Material: ABS (Acrylonitrile Butadiene Styrene) Plastic
Finish: Gray
Packing: Per Piece, with screws



CODE	SIZE
RHSAC-41117	156mm(W) x 265-400mm(D) x 167mm(H)



BUILT-IN WASTEBIN

Brand: ALTUS
Material: Stainless Steel 201 and PP Plastic
Finish: Blue
Application: Top Mounted
Capacity: 8 Liters
Function: Waste Storage System
Packing: Per Set, includes Per Set, 1pc Dust Bin with Stainless Steel Lid, Garbage Bag Press Ring, Countertop Fixing Ring & Plastic Trash Bin

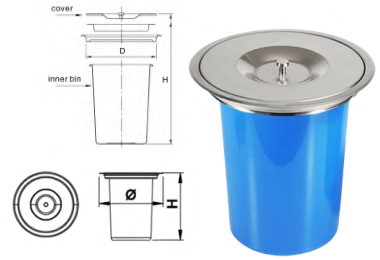

CODE	SIZE
RHAC-23106	472mm(W) x 369mm(D) x 46mm(H)



PULLOUT WASTEBIN (SINGLE)

with Soft Close Mechanism



Brand: ALTUS
Material: PVC
Color/Finish: Light Grey
Carcass Width: 400mm
Shape: Rectangular
Opening Mechanism: Pullout
Capacity: 35 Liters
Packaging: Per Set
Function: Waste Storage System

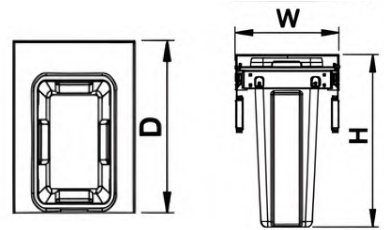

CODE	SIZE
RHSAC.23133013.1.GRY	362-368(W) x 510(D) x 570mm(H)



PULLOUT WASTEBIN (DOUBLE)

with Soft Close Mechanism



Brand: ALTUS
Material: PVC
Color/Finish: Light Grey
Carcass Width: 350mm
Shape: Rectangular
Opening Mechanism: Pullout
Capacity: 36L (2X18 Liters)
Packaging: Per Set
Function: Waste Storage System

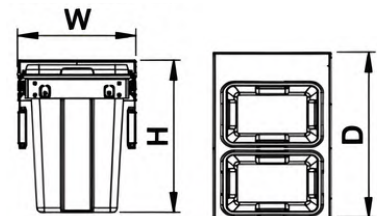

CODE	SIZE
RHSAC.23133013.2.GRY	312-318mm(W) x 510mm(D) x 480mm(H)



**WARDROBE
ACCESSORIES**
AND STORAGE SOLUTIONS



WEAVED WARDROBE CLOTH BASKET

with Soft Close Mechanism

- Brand:** ALTUS
- Material:** Aluminium Alloy + Steel + Plastic
- Finish:** Nano-Electroplated
- Load:** 5-6kgs
- Capacity:** Side Mounted
- Installation:** Per Set, includes 2pcs Cover,
- Packing:** 1pair Concealed Slides & 8pcs screws & Installation Guide

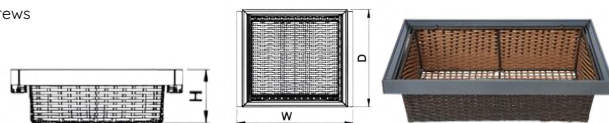

CODE	SIZE	CABINET WIDTH
RHSCL-01600	480mm(D) x 535mm(W) x 185mm(H)	600mm
RHSCL-01900	480mm(D) x 835mm(W) x 185mm(H)	900mm

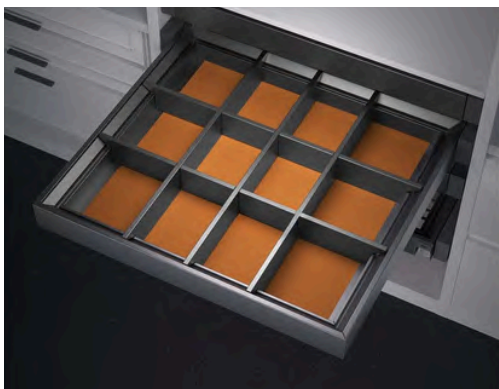

JEWELRY/MULTI-BIN STORAGE DRAWER

with Soft Close Mechanism

- Brand:** ALTUS
- Material:** Aluminium Alloy + Steel + PU Leather
- Finish:** Nano-electroplated
- Color:** Iron Grey
- Installation:** Side Mounted
- Packing:** Per Set, includes 2pcs Cover, 1pair Concealed Drawer Slides, set Mounting screws & Installation Manual

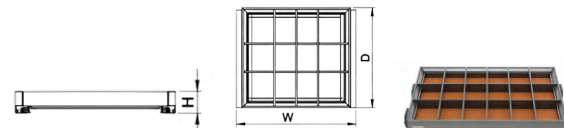

CODE	SIZE	CABINET WIDTH
RHSCL-02600	480mm(D) x 538mm(W) x 60mm(H)	600mm



WARDROBE CLOTH BASKET

with Soft Close Mechanism

- Brand:** ALTUS
- Material:** Aluminium Alloy + Steel + Plastic
- Finish:** Nano-electroplated
- Color:** Iron Grey
- Installation:** Side Mounted
- Packing:** Per Set, includes 2pcs Cover, 1pair Concealed Drawer Slides, set Mounting screws & Installation Manual

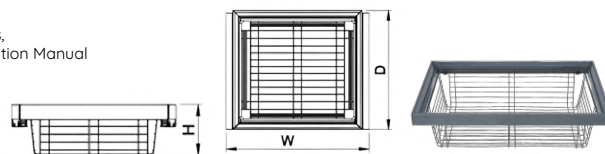

CODE	SIZE	CABINET WIDTH
RHSCL-03600	477mm(D) x 535mm(W) x 203mm(H)	600mm



PULL OUT PANTS RACK

with Soft Close Mechanism

- Brand:** ALTUS
- Material:** Aluminium Alloy + Steel + Plastic
- Finish:** Nano-electroplated
- Color:** Iron Grey
- Installation:** Side Mounted
- Packing:** Per Set, includes 1pc Frame, 2pcs Cover, 1pair Concealed Slides, 6pcs Rails & 8pcs Screws & Installation Manual

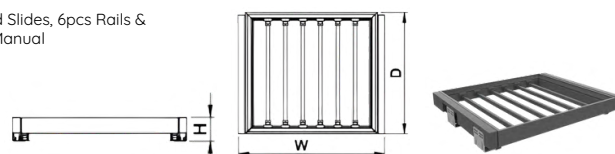

CODE	SIZE
RHSCL.04600	314mm(W) x 460mm(D) x 477mm(H)

WARDROBE LIFT

Brand: ALTUS
Material: Aluminium Alloy + Steel + Plastic
Finish: Pole - Chrome Plated/Handle - Plastic
Load: 10kgs
Capacity: Side Mounted
Installation: Per Set, includes 1pair Left & Right Mechanism, 1pc Hanging Pole,
Packing: 1pc Main Pole with Handle, 1pc Allen Wrench/Hexagon Key, 2pcs Plastic Bracket, Mounting Screws & Installation Manual



CODE	CABINET WIDTH
RHSCL-0514105	890-1210mm (internal)

LAUNDRY BIN BASKET

with Soft Close Mechanism



Brand: ALTUS
Material: Steel and Plastic
Finish: Nano-electroplated
Color: White and Blue
Capacity: 2*35Liters
Installation: Bottom Mounted
Packing: Per Set, includes 2pcs baskets, Front Panel Fittings, Soft Closing Guides, Mounting screws & Installation Manual

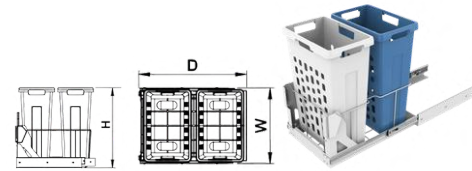

CODE	SIZE	CABINET WIDTH
RHS21-01450	392mm(W) x 497mm(D) x 570mm(H)	450mm

NEW

SAFETY DRAWER BOX

with Fingerprint and Digital Lock



Brand: ALTUS
Material: Steel and Velvet
Color: Black (Outside Drawer) Grey (Inner Drawer)
Feature: Touch Screen Password Unlocking
Packing: Per Set, Lock Box, USB Power Cable, 2pcs Spare Key and 8pcs Screws

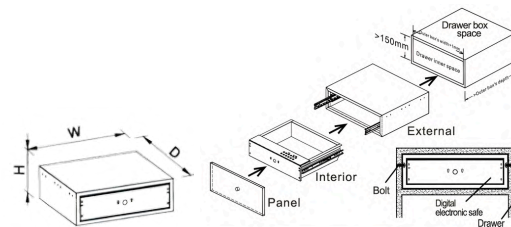

CODE	CABINET HEIGHT	CABINET WIDTH
RHS23-01600.1.GRY	564mm(W) 400mm(D) x 150mm(H)	600mm
RHS23-01900.1.GRY	864mm(W) 400mm(D) x 150mm(H)	900mm

NEW

SAFETY DRAWER BOX

with Fingerprint and Digital Lock



Brand: ALTUS
Material: Steel and Velvet
Color: Black (Outside Drawer) Grey (Inner Drawer)
Feature: Touch Screen Password Unlocking
Packing: Per Set, Lock Box, USB Power Cable, 2pcs Spare Key and 8pcs Screws

CODE	SIZE	CABINET WIDTH
RHS23-01600.2.GRY	764mm(W) x 450mm(D) x 150mm(H)	600mm
RHS23-01900.2.GRY	864mm(W) x 450mm(D) x 150mm(H)	900mm

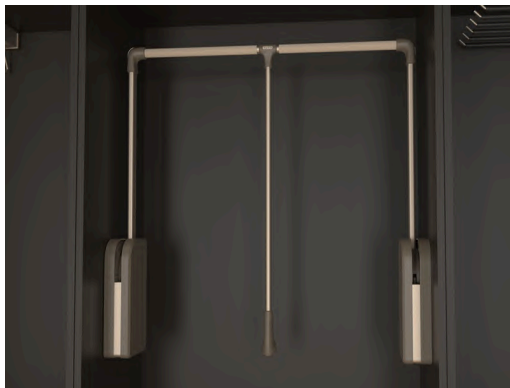

WARDROBE LIFT - PREMIUM

with Soft Closing Mechanism (Manual Up & Down)



Brand: ALTUS
Series: Premium - Gala
Material: Powder Coated Aluminum
Color: Champagne
Cabinet Height: 2400mm (Maximum)
Packing: Per Set, includes 1pair Left & Right Mechanism, set of Mounting Screws & Installation manual

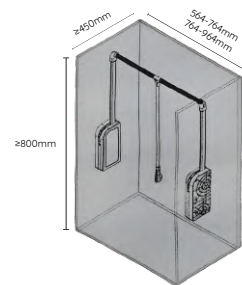

CODE	CABINET HEIGHT	CABINET WIDTH
RHSCL-0510020	770mm(W) x 140mm(D) x 764-964mm(H)	800-1000mm (Outside)



JEWELRY STORAGE (PREMIUM)

with Soft Close Mechanism



Brand: ALTUS
Series: Premium - Gala
Material: Aluminium Frame with Leather
Color: Champagne
Installation: Side Mounted
Packing: Per Set, includes 2pcs Cover, 1pair Concealed Slides 8pcs screws and Installation Manual

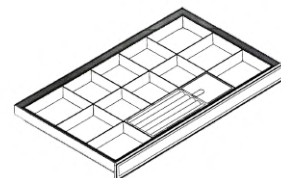

CODE	SIZE	CABINET WIDTH
RHSCL-06800	764mm(W) 429mm(D) x x 68mm(H)	800mm
RHSCL-06900	864mm(W) 429mm(D) x x 68mm(H)	900mm



WEAVE BASKET (PREMIUM)

with Soft Close Mechanism



Brand: ALTUS
Series: Premium - Gala
Material: Aluminium Frame with Leather
 PP Rattan material (Flame-retardant)
Color: Champagne
Cabinet Depth: 450mm
Installation: Side Mounted
Packing: Per Set, includes 2pcs Cover, 1pair Concealed Slides, 8pcs screws & Installation Manual

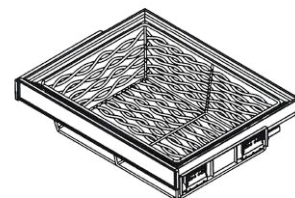

CODE	SIZE	CABINET WIDTH
RHSCL-07800	764mm(W) 429mm(D) x x 152mm(H)	800mm
RHSCL-07900	864mm(W) 429mm(D) x x 152mm(H)	900mm



TROUSERS RACK - PREMIUM

with Soft Close Mechanism

Brand: ALTUS
Series: Premium - Gala
Material: Aluminium Frame with Leather
Color: Champagne
Cabinet Depth: 450mm
Installation: Side Mounted
Packing: Per Set, includes 2pcs Cover, 1pair Concealed Slides, 8pcs screws & Installation Manual



CODE	SIZE	CABINET WIDTH
RHSCL-08800	764mm(W) 429mm(D) x x 68mm(H)	800mm
RHSCL-08900	864mm(W) 429mm(D) x x 68mm(H)	900mm



ROTATING SHOE RACK
with Soft Closing Mechanism



Brand: ALTUS
Series: Premium - Gala
Material: Aluminum Frame, PVC and Leather
Finish: Champagne
Cabinet Width: 900mm
Height: 100mm
Adjustment: 360 Degrees
Rotation: Can hold up to 40 Pairs of shoes
Load Capacity: Per Set, includes 12pcs Trays, Frame, Up and Down Runners, Plastic Fixing Parts, mounting screws and Installation Manual
Packing:

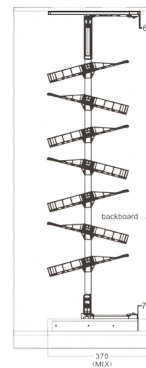
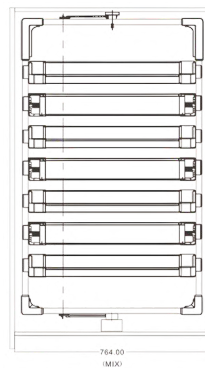

CODE	SIZE
RHSL-0910C20-12	764mm(W) x 400mm(D) x 1950-2150mm(H)



DRAWER BOX
with Soft Close Mechanism



Brand: ALTUS
Series: BELA
Material: Aluminum Frame with Leather
Color: Purple/Rusty Red
Packing: Per Set, with Installation Manual

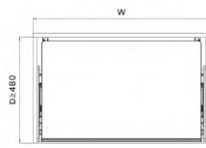

CODE	SIZE	DESCRIPTION
RHSL-10800.RED	764mm (W) x 471mm (D) x 81mm (H)	Low
RHSL-10800.PUR	764mm (W) x 471mm (D) x 81mm (H)	Low
RHSL-11800.RED	764mm (W) x 471mm (D) x 108mm (H)	Medium
RHSL-11800.PUR	764mm (W) x 471mm (D) x 108mm (H)	Medium



DRAWER BOX
with Soft Close Mechanism

Brand: ALTUS
Series: BELA
Material: Nano Powder Spraying Finish Carbon Steel/PU Leather
Color: Purple/Rusty Red
Packing: Per Set, with Installation Manual

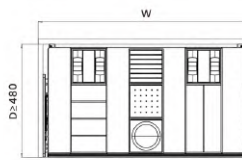

CODE	SIZE	CABINET WIDTH
RHSL-12800.RED	764mm (W) x 471mm (D) x 81mm (H)	800mm
RHSL-12800.PUR	764mm (W) x 471mm (D) x 81mm (H)	800mm



NEW

UNDERWEAR DRAWER
with Soft Close Mechanism



Brand: **ALTUS**
Series: **BELA**
Material: Nano Powder Spraying Finish
Carbon Steel/PU Leather
Color: Purple/Rusty Red
Packing: Per Set, with Installation Manual

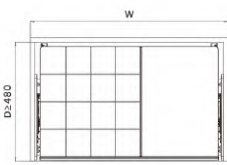
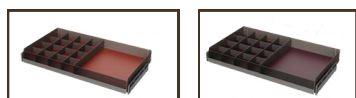

CODE	SIZE	CABINET WIDTH
RHSCL-13800.RED	764mm (W) x 471mm (D) x 108mm (H)	800mm
RHSCL-13800.PUR	764mm (W) x 471mm (D) x 108mm (H)	800mm



NEW

TROUSERS RACK
with Soft Close Mechanism



Brand: **ALTUS**
Series: **BELA**
Material: Nano Powder Spraying Finish
Carbon Steel/PU Leather
Color: Purple/Rusty Red
Packing: Per Set, with Installation Manual

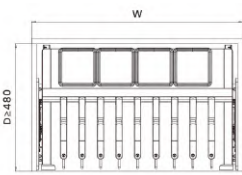

CODE	SIZE	CABINET WIDTH
RHSCL-14800.RED	764mm (W) x 471mm (D) x 84mm (H)	800mm
RHSCL-14800.PUR	764mm (W) x 471mm (D) x 84mm (H)	800mm



NEW

HANGER ROD - END COVER

Brand: **ALTUS**
Series: **BELA**
Material: Nano Powder Spraying Finish
Carbon Steel with Grip Rubber
Color: Dark Grey
Packing: Per pair, with Mounting Screws
and Installation Manual

CODE	SIZE
RHSCL-25001	30mm (W) x 21mm (D) x 85mm (H)

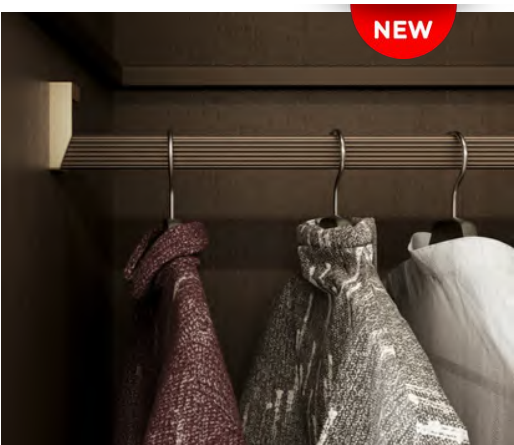

NEW

DRAWER BOX
with Soft Close Mechanism

Brand: **ALTUS**
Series: **BELA**
Material: Nano Powder Spraying Finish
Carbon Steel with Grip Rubber
Color: Dark Grey
Packing: Per piece, with Installation Manual



CODE	SIZE
RHSCL-25003	3m (3000mm)



ROUND TUBE HOLDER (FLANGE)

Brand: ALTUS
 Material: Steel
 Finish: Chrome Plated
 Packing: Per Piece

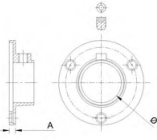

CODE	DIAMETER	CABINET WIDTH
RHSAC-12114	Φ25mm	55mm(D) x 4mm (h) x 16mm (H)



OVAL TUBE HOLDER

Brand: ALTUS
 Material: Zamac
 Finish: Nickel Plated
 Packing: Per Piece

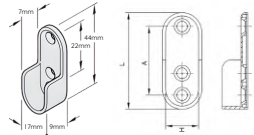

CODE	SIZE
RHSAC-12102	15mm(D) x 44mm(L) x 32mm (A)



CENTER OVAL POST - ADJUSTABLE

Brand: ALTUS
 Material: Zamac
 Finish: Nickel Plated
 Packing: Per Piece

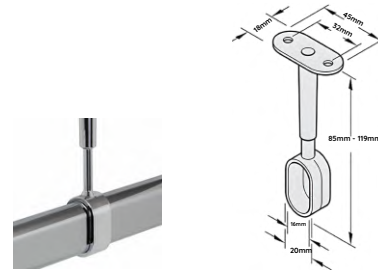

CODE	SIZE
RHSAC-12303	16mm (H) x 31mm



END OVAL POST - ADJUSTABLE

Brand: ALTUS
 Material: Zamac
 Finish: Nickel Plated
 Packing: Per Piece

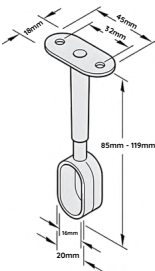

CODE	SIZE
RHSAC-12304	16mm (H) x 31mm



END OVAL POST - ADJUSTABLE

Brand: ALTUS
 Material: Aluminum Alloy
 Finish: Chrome Plated
 Packing: Per Piece

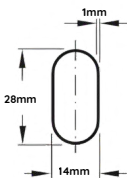

CODE	SIZE	THICKNESS
RHSAC-13101	3000mm (3m)	0.8mm - 1mm



STEEL HANGER ROD - OVAL

Brand: ALTUS
 Material: Steel
 Finish: Chrome Plated
 Packing: Per Piece

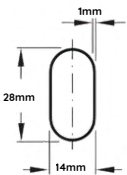

CODE	SIZE	THICKNESS
RHSAC-13102	3000mm (3m)	0.5mm - 1.5mm



CONNECTING BOLT

Brand: ALTUS
 Material: Steel + Plastic
 Finish: White Zinc Plated
 Packing: 100pcs/pack

For $\Phi 15$ eccentric cam, self tapping thread, with plastic cover
 Wood thread $\Phi 6^{\circ}B11A$, Pozzi Head, No across, Black plastic

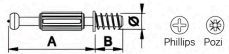

CODE	SIZE
RHSHD-05280	34mm x $\Phi 6.5$ mm; C30; $\Phi 7.7$ mm



CONNECTING BOLT

Brand: ALTUS
 Material: Zamac
 Finish: Nickel Plated
 Packing: 100pcs/pack

For $\Phi 15$ eccentric cam, metric thread
 Wood thread $\Phi 6^{\circ}B11A$, Pozzi Head, No across, Black plastic

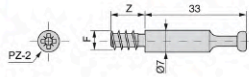

CODE	SIZE
RHSHD-05298	34mm x $\Phi 7$ x M6 Thread



GLUED DOWEL

Brand: ALTUS
 Material: Nylon Plastic
 Finish: White/RAL9010
 Packing: 100pcs/pack

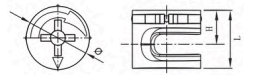

CODE	SIZE
RHSHD-05117	$\Phi 15$ mm x 13mm(L); 9mm(H)



ECCENTRIC CAM

Brand: ALTUS
 Material: Zamac
 Finish: White Zinc Plated
 Packing: 100pcs/pack

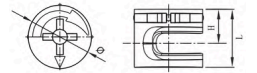

CODE	SIZE
RHSHD-05117	$\Phi 15$ mm x 13mm(L); 9mm(H)



PLASTIC SHELF SUPPORT

Brand: ALTUS
 Material: Steel + PC
 Finish: White/Clear
 Packing: 100pcs/pack

115 type, bolt end, transparent w/ R angle.

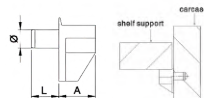

CODE	SIZE
RHSAC-37115	$\Phi 5$ mm x L8mm x A8.7mm; W11mm



PIN TYPE SHELF SUPPORT

Brand: ALTUS
 Material: Steel
 Finish: White Zinc Plated
 Packing: 100pcs/pack

117 type, with $\Phi 7$ corner in the middle, both ends with R angle

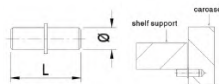

CODE	SIZE
RHSAC-37117	$\Phi 5$ mm x L8mm x A8.7mm; W11mm



WOOD DOWEL

Brand: ALTUS
 Material: Wood
 Finish: Natural
 Packing: 200pcs/pack

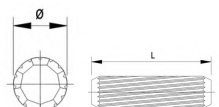

CODE	SIZE
RHSHD-05493	$\Phi 8$ mm x 30mm(L)



GLASS SHELF SUPPORT WITH SUCTION CUP

Brand: **ALTUS**
 Material: Steel + Plastic
 Finish: White Zinc Plated
 Packing: 100pcs/pack

109 type, bolt end w/ R angle.
 w/ transparent cup, PVC, Ø1xH3



CODE	SIZE
RHSAC-37109	Φ5mm x 8mm(L) x A: 14.5mm



PLASTIC CORNER CONNECTOR WITH COVER

Brand: **ALTUS**
 Material: PE (Polyethylene Plastic)
 Finish: White/RAL9010
 Packing: 100pcs/pack

With face panel, removable

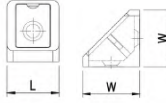

CODE	SIZE
RHSHD-05509	20mm(W) x 17mm(L)



PLASTIC CORNER CONNECTOR WITH COVER

Brand: **ALTUS**
 Material: PE (Polyethylene Plastic)
 Finish: White/RAL9010
 Packing: 100pcs/pack

With face panel, removable

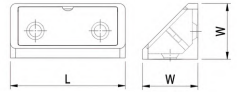

CODE	SIZE
RHSHD-05464	Φ11mm x 11mm(L) x M6



HANGING CABINET SUSPENSION BRACKET

Brand: **ALTUS**
 Material: Steel + PS
 Finish: Pure White/RAL9010
 Packing: 2sets/pack, includes 1pair Hanging Bracket & 2pcs Wall Plate

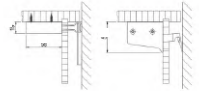

CODE	SIZE
RHSAC-21101	20mm (W) x 42mm (L)



Φ35 RECESSED WORKTOP CONNECTOR (W/PLASTIC CLIP)

Brand: **ALTUS**
 Material: Steel + Plastic
 Finish: Zinc Plated
 Packing: Per Piece

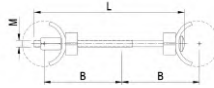

CODE	SIZE
RHSHD-053308-01	Φ35mm x (48.5-55)
RHSHD-053308-02	Φ35mm x (74-80.5)



CABLE GROMMET

Brand: **ALTUS**
 Material: ABS Plastic
 Finish: Black/Gray
 Packing: Per Piece

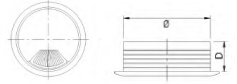

CODE	SIZE	FINISH
RHSHD-30102.BLK	Φ60mm D=22mm	Black/RAL9005
RHSHD-30102.GRY	Φ60mm D=22mm	Grey/RAL9010
RHSHD-30102-02.BLK	Φ80mm D=21mm	Black/RAL9005
RHSHD-30102-02.GRY	Φ80mm D=21mm	Grey/RAL9010



ADJUSTABLE PLINTH FOOT

Brand: **ALTUS**
 Material: ABS
 Finish: Black
 Capacity: 100kgs.
 Packing: Per Pack/4pcs per pack with 2 Clips

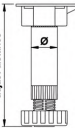

CODE	SIZE	DIAMETER
RHSHD.22301105.BLK	95-120mm	28mm



PLINTH CLIP

Brand: **ALTUS**
 Material: ABS
 Finish: Black
 Packing: Per Piece

CODE	DESCRIPTION
RHSHD-22901005.BLK	for RHSHD.22301105.BLK



FOLDING SHELF BRACKET

Brand: **ALTUS**
 Material: Steel
 Finish: White
 Capacity: 45kgs
 Packing: Per Pair, includes 2pcs Foldable Shelf Brackets & 7pcs Mounting Screws



CODE	SIZE	INSTALLATION
RHSHD-39102	12" - 290mm(L) x 135mm(H) x 21mm(W)	Wall Mount



ADHESIVE DOOR BUMBER

Brand: **ALTUS**
 Material: Rubber
 Finish: Clear
 Packing: Per Pad/100pc per pad

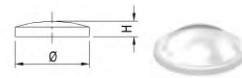

with 3M brand adhesive glue

CODE	SIZE
RHSAC-43102-01	Φ8mm x 1.5mm (H)
RHSAC-43102-02	Φ8mm x 3mm (H)



VENTILATION GRID

Brand: **ALTUS**
 Material: Aluminum
 Finish: Anodized Silver, Black 9005
 Packing: Per Piece

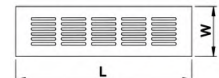

CODE	SIZE	COLOR
RHSAC-22108.300	300mm (L) x 80mm (W)	Anodized Silver
RHSAC-22108.300.BLK	300mm (L) x 80mm (W)	Black 9005
RHSAC-22108.500	500mm (L) x 80mm (W)	Anodized Silver
RHSAC-401001A	400mm (L) x 60mm (W)	Anodized Silver



PVC BASEBOARD

Brand: **ALTUS**
 Material: PVC
 Color: Anodized Silver, Black RAL 9005
 Finish: Hairline
 Packing: Per Piece



CODE	SIZE	FINISH
RHSAC.217005.14	4000mm (L) x 100mm (H)	Anodized Silver
RHSAC.217005.14.BLK	4000mm (L) x 100mm (H)	Black/RAL9005
RHSAC.217005.15	4000mm (L) x 150mm (H)	Anodized Silver
RHSAC.217005.15.BLK	4000mm (L) x 150mm (H)	Black/RAL9005



BASEBOARD CONNECTOR

Brand: **ALTUS**
 Material: PVC
 Color: Anodized Silver, Black RAL 9005
 Finish: Hairline
 Angle: 180 Degree
 Packing: Per Piece

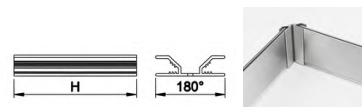

CODE	HEIGHT	COLOR
RHSAC.54120.100	100mm	Anodized Silver
RHSAC.54120.100.BLK	100mm	Black RAL 9005



CASTER WHEEL - DUAL WHEEL

Brand: **ALTUS**
 Material: Polypropylene (PP)
 Color: Black
 Type: Plate Type-Swivel
 Packing: Per Piece

CODE	DIAMETER
RHSAC.06107.05	50mm

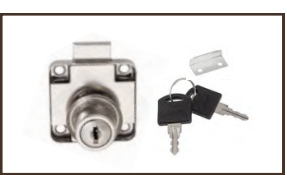

DRAWER LOCK

Brand: **ALTUS**
 Material: Steel
 Finish: Chrome Plated
 Packing: Per Set, with 2 Keys

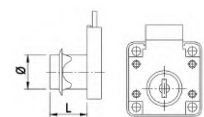

CODE	DESCRIPTION
RHSAC.09101.130	Core not Removable



CAM LOCK

Brand: **ALTUS**
 Material: Steel
 Finish: Chrome Plated
 Packing: Per Set, with 2 Keys

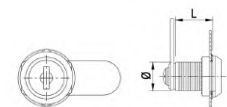

CODE	SIZE
RHSAC.09302.016	Φ16mm x 18mm(H)



SCREW TYPE BUFFER

Brand: **ALTUS**
 Material: POM
 Finish: Anodized
 Packing: Per Piece, with screws

153 type, 4-5N, w/ plate

CODE	SIZE
RHSHD-20153	62mm (L) x 20mm (W) x 18mm (H)



SCREW TYPE BUFFER

Brand: **ALTUS**
 Material: POM
 Finish: Anodized
 Packing: Per Piece, with screws

156 type, 4-5N, w/ plate

CODE	SIZE
RHSHD-20156	53mm (L) x 44.5mm (W) x 12.5mm (H)



INSERT TYPE DOOR BUFFER

Brand: **ALTUS**
 Material: POM
 Finish: Anodized
 Packing: Per Piece, with screws

148 type, 4-5N

CODE	SIZE
RHSHD-20148	50mm (L) x 12mm (dia) x 12mm (H)



MAGNETIC CATCH - LIGHT DUTY

Brand: **ALTUS**
 Material: POM
 Finish: Gray
 Packing: Per Set, includes catch, Steel disc, 1pc screw, and 1pc plastic dowel



CODE	SIZE
RHSHD-40202	82mm (L) x 10mm (W)



MAGNETIC CATCH - HEAVY DUTY

Brand: **ALTUS**
 Material: POM
 Finish: Gray
 Packing: Per Set, includes catch, Steel disc, 1pc screw, and 1pc plastic dowel



CODE	SIZE
RHSHD-40204	84mm (L) x 14mm (W) x 19.5mm (H)



SMART PUSH

PUSH TO OPEN WITH SOFT CLOSE BUFFER

Brand: **ALTUS**
 Trigger Stroke: 2mm
 Pop-Out Stroke: 56mm
 Packing: Per Set, with Installation Manual
 Application: Can be used on wooden doors or aluminum doors

FEATURES

- Flexible installation
- Can be installed at side panel or layer panel
- Easy installation screw on fixing
- Small trigger stroke, big trigger area

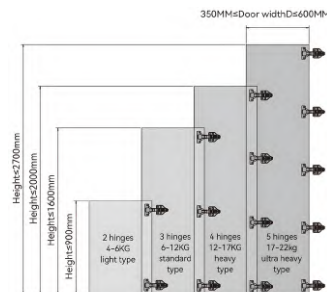

CODE	DOOR WIDTH	DOOR WEIGHT	DOOR HEIGHT
RTT-3003 (A) LIGHT	For 350mm-600mm	4-6kgs	≤1000mm
RTT-3003 (B) STANDARD	For 350mm-600mm	12-17kgs	≤2000mm
RTT-3003 (C) HEAVY DUTY	For 350mm-600mm	22-25kgs	≤2700mm

Door width=D
 (**Reserve space to assemble the decorative cover)
 350mm≤D≤450mm,
 L takes the maximum value, L=D
 450mm≤D≤600mm, L=450mm

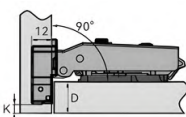
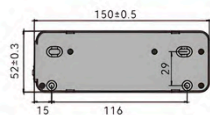

A Coverage calculation table: H=15+K-D

	3	4	5	6	7
0	18	19	20	21	22
2	16	17	18	19	20
4	14	15	16	17	18

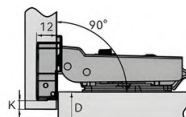

B Coverage calculation table: H=5+K-D

	3	4	5	6	7
0	8	9	10	11	12
2	6	7	8	9	10
4	4	5	6	7	8

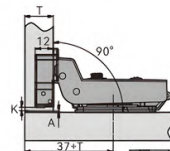

C Coverage calculation table: H=A+K-3

	3	4	5	6	7
0	0	-1	-2	-3	-4
2	2	1	0	-1	-2
4	4	3	2	1	0

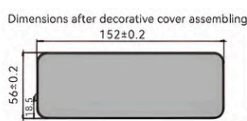



STAINLESS STEEL HANDLE (HOLLOW)

Brand: **ALTUS**
 Material: SS 201, Hollow
 Diameter: 10mm
 Height: 30mm
 Finish: Satin
 Color: Silver
 Packing: Per Piece, with screws

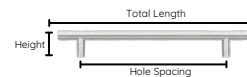

CODE	TOTAL LENGTH	HOLE SPACING
RHS12-0156.SS	156mm	96mm
RHS12-01188.SS	188mm	128mm
RHS12-01220.SS	220mm	160mm



MATTE BLACK HANDLE

Brand: **ALTUS**
 Material: Stainless Steel
 Finish: Matte
 Color: Black
 Diameter: 12mm
 Height: 32mm
 Packing: Per Piece, with screws

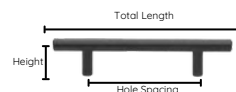

CODE	TOTAL LENGTH	HOLE SPACING
RHS12-02188.SS.BLK	188mm	128mm
RHS12.02252.SS.BLK	252mm	192mm



BLACK ZAMAC HANDLE

Brand: **ALTUS**
 Material: Zamac/Zinc
 Finish: Matte
 Color: Black
 Width: 18.5mm
 Height: 25.5mm
 Packing: Per Piece with Screws

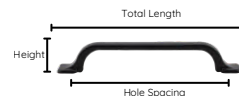

CODE	TOTAL LENGTH	HOLE SPACING
RHS12.04160ZN.BLK	197mm	160mm



MATTE BLACK HANDLE

Brand: **ALTUS**
 Material: Zamac
 Finish: Matte
 Color: Black
 Width: 26mm
 Height: 28mm
 Packing: Per Piece with Screws

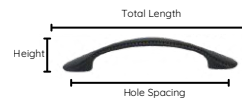

CODE	TOTAL LENGTH	HOLE SPACING
RHS12-05128.ZN.BLK	162.5mm	128mm



MATTE BLACK KNOB HANDLE

Brand: **ALTUS**
 Material: Zamac
 Finish: Matte
 Color: Black
 Diameter: 30mm
 Packing: Per Piece with Screws



CODE	DIAMETER	HEIGHT
RHS12-05KB.ZN.BLK	30mm	24mm



ANODIZED SILVER HANDLE

Brand: **ALTUS**
 Material: Aluminum
 Finish: Aluminum Anodized
 Packing: Per Piece, with Screws

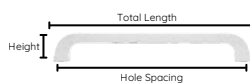

CODE	LENGTH	HOLE SPACING
RHS12-4456.160.AL(RWF)	166mm	160mm

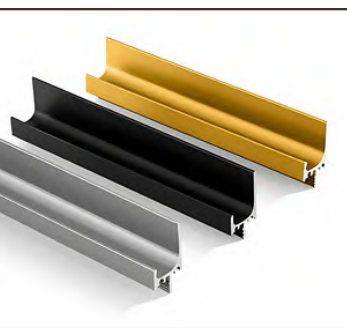

ALUMINUM CONTINUOUS GRAB HANDLE

Brand: **ALTUS**
 Material: Aluminum
 Color: Matte Black/Aluminum Silver/
 Shiny Gold/Rose Gold
 Application: 18mm
 Packing: Per Piece



CODE	SIZE	COLOR
RHS12-357.AS	3000mm (L) x 20mm (W) x 35.7mm (H)	Aluminum Silver
RHS12-357.MB	3000mm (L) x 20mm (W) x 35.7mm (H)	Matte Black
RHS12-357.SG	3000mm (L) x 20mm (W) x 35.7mm (H)	Shiny Gold
RHS12-357.RG	3000mm (L) x 20mm (W) x 35.7mm (H)	Rose Gold



ALUMINUM CONTINUOUS GRAB HANDLE

Brand: **ALTUS**
 Material: Aluminum
 Color: Matte Black/Aluminum Silver/
 Shiny Gold/Rose Gold
 Application: 18mm
 Packing: Per Piece

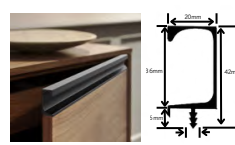

CODE	SIZE	COLOR
RHS12-348.AS	3000mm (L) x 20mm (W) x 42mm (H)	Aluminum Silver
RHS12-348.MB	3000mm (L) x 20mm (W) x 42mm (H)	Matte Black
RHS12-348.SG	3000mm (L) x 20mm (W) x 42mm (H)	Shiny Gold
RHS12-348.RG	3000mm (L) x 20mm (W) x 42mm (H)	Rose Gold



ALUMINUM RECESS HANDLE - L TYPE

Brand: **ALTUS**
 Material: Aluminum
 Color: Black/Chrome Silver
 Finish: Matte
 Length: 3 Meters
 Packing: Per Piece

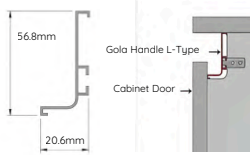

CODE	SIZE	COLOR
RHS12-0225401.MC	20.6mm (W) x 56.8mm (H)	Chrome Silver
RHS12-0225401.MB	20.6mm (W) x 56.8mm (H)	Black



ALUMINUM RECESS HANDLE - U TYPE

Brand: **ALTUS**
 Material: Zamac
 Color: Matte
 Finish: Black
 Length: 30mm
 Packing: Per Piece with Screws

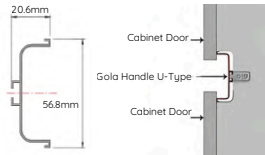

CODE	SIZE	COLOR
RHS12-0225402.MC	20.5mm (W) x 74.8mm (H)	Chrome Silver
RHS12-0225402.MB	20.5mm (W) x 74.8mm (H)	Black

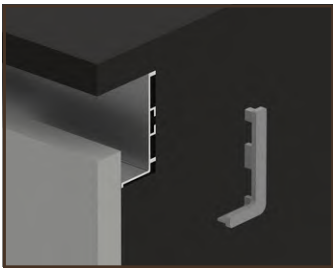

END COVER
FOR RHS12-0225401

Brand: ALTUS
Material: Zinc
Thickness: W9
Color: Black/Chrome Silver
Finish: Matte
Packing: Per Pair, (Left and Right)

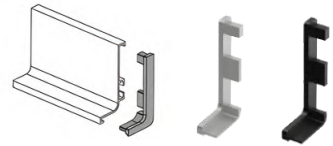

CODE	SIZE	COLOR
RHS12-0225498EC.MC	28mm (W) x 59mm (H)	Chrome Silver
RHS12-0225498EC.MB	28mm (W) x 59mm (H)	Black

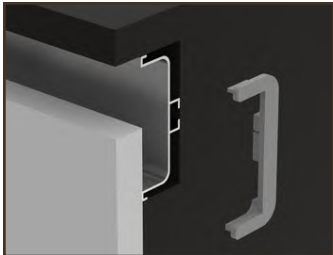

END COVER
RHS12-0225402

Brand: ALTUS
Material: Zinc
Thickness: W9
Color: Black/Chrome Silver
Finish: Matte
Packing: Per Pair, (Left and Right)

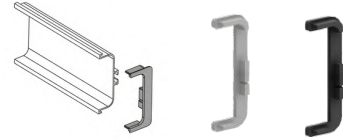

CODE	SIZE	COLOR
RHS12-0225497EC.MC	29.5mm (W) x 72.5mm (H)	Chrome Silver
RHS12-0225497EC.MB	29.5mm (W) x 72.5mm (H)	Black

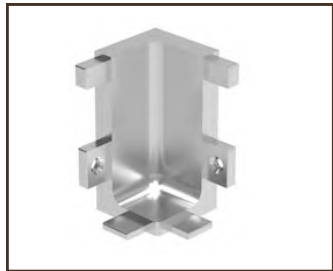

INTERNAL CORNER CONNECTOR

Brand: ALTUS
Material: Zinc
Color: Black/Chrome Silver
Finish: Matte
Packing: Per Piece

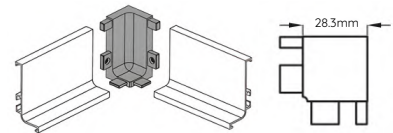

CODE	SIZE	COLOR
RHS12-0225499ICC.MC	28.3mm (W) x 28.3mm (H) x 57.1mm	Chrome Silver
RHS12-0225499ICC.MB	28.3mm (W) x 28.3mm (H) x 57.1mm	Black



EXTERNAL CORNER CONNECTOR

Brand: ALTUS
Material: Zinc
Color: Black/Chrome Silver
Finish: Matte
Packing: Per Piece

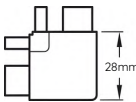

CODE	SIZE	COLOR
RHS12-0225496ECC.MC	7.9mm (W) x 28mm (H) x 57mm (L)	Chrome Silver
RHS12-0225496ECC.MB	7.9mm (W) x 28mm (H) x 57mm (L)	Black



BRACKET CONNECTOR

Brand: ALTUS
Material: Steel
Finish: Blue Zinc
Packing: Per Pair with Screws

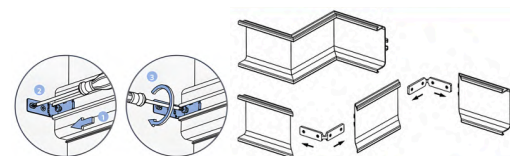

CODE	SIZE	COLOR
RHS12-0225495LC.ZP	13mm (W) x 35mm (H)	Chrome Silver



CABINET SLIDING

DOOR SYSTEMS

EXTERNAL SLIDING DOOR SYSTEM (2-DOOR)



Brand: ALTUS
Material: Chrome Plated Steel
Door Thickness: ≤ 20mm
Door Width: 500mm-1200mm
Door Height: ≤ 2500mm
Door Weight: 10-50kgs
Packing: Per Set

FEATURES

- External Roller Design
- No grooving required
- Patented Concealed Damper
- Soft closing system with anti-jump and automatic hook coupling function (Anti-decoupling)

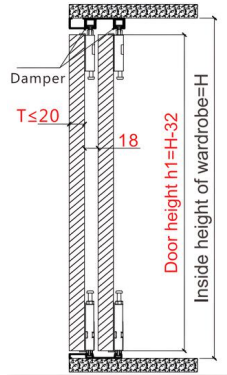

CODE	DESCRIPTION	APPLICATION
RT-409	Roller and Damper mechanisms only	Wood

SET INCLUDES:

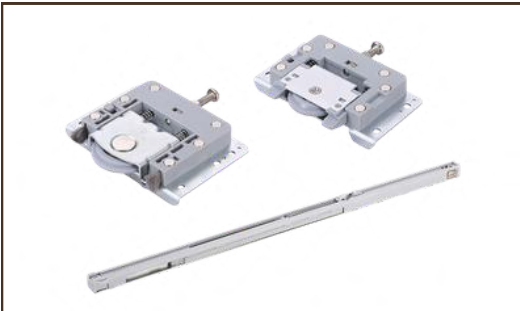

4pcs Upper Runner, 4pcs Down Runner and 4pcs Damper

SOLD SEPARATELY

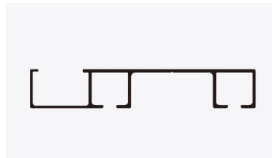

Upper Rail
Code: RT-409-20

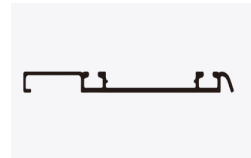

Down Rail
Code: RT-409-20

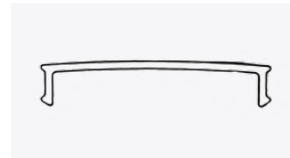

Down Rail Aluminum Cover
Code: RT-409DC
*OPTIONAL

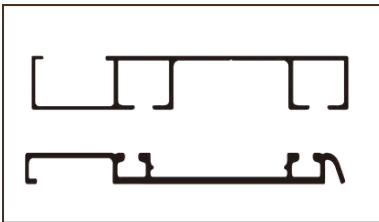

UP AND DOWN ALUMINUM RAIL

FOR RT-409 EXTERNAL SLIDING DOOR SYSTEM

Brand: ALTUS
Material: Aluminum
Packing: Per Set

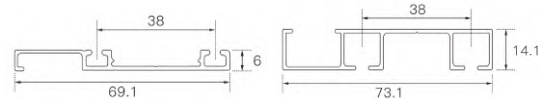

CODE	LENGTH
RT-409-20	3000mm (3 meters)

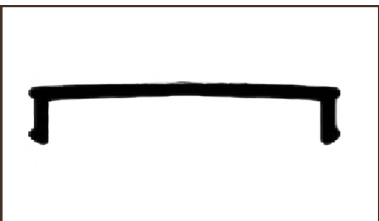

ALUMINUM DOWN RAIL COVER

FOR RT-409 EXTERNAL SLIDING DOOR SYSTEM

Brand: ALTUS
Material: Aluminum
Packing: Per Piece

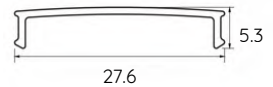

CODE	LENGTH
RT-409DC	3000mm (3 meters)

HANGING SLIDING DOOR SYSTEM



Brand: ALTUS
Material: Zinc Steel
Wood Door Thickness: 16mm - 46mm
Single Door Width: 700mm - 1500mm
Door Height: ≤ 2500mm
Single Door Weight: 20 - 80kgs
Requirement: 2 Door/3Doors
Door Application: Per Set
Packing:

FEATURES

- Gentle and Smooth Door Opening & Closing
- Damper for both Top and Bottom Track for Perfect Soft Closing
- Easy Assemble Damper, pre-mounted with Fittings
- Anti-Jump Mechanism to Prevent Wheel and Door Disengagement

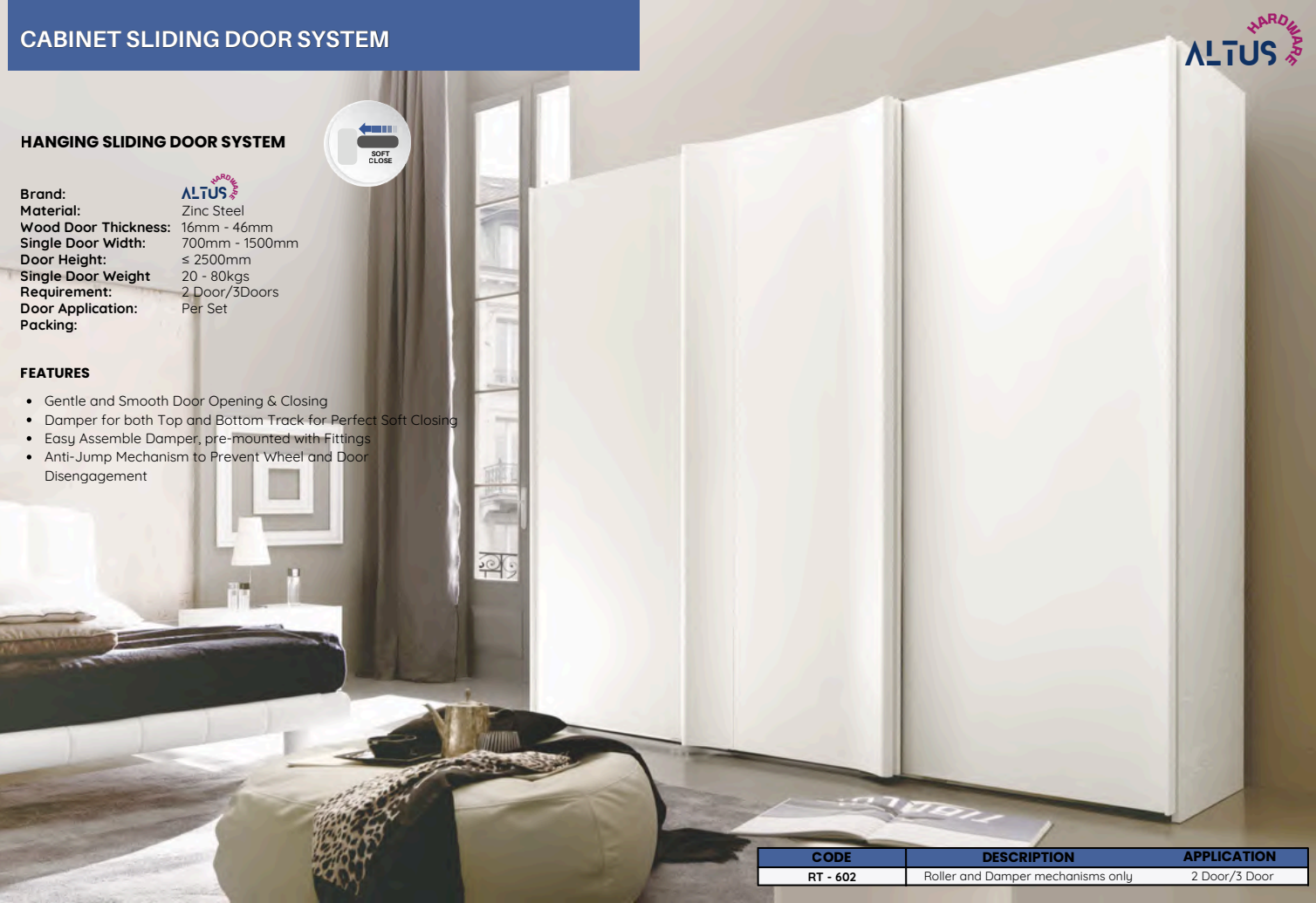

CODE	DESCRIPTION	APPLICATION
RT - 602	Roller and Damper mechanisms only	2 Door/3 Door

SET INCLUDES:



Top Fitting Outer Door



Top Fitting Inner Door



Bottom Fitting Outer Door



Bottom Fitting Inner Door



Bottom Track
*SOLD SEPARATELY

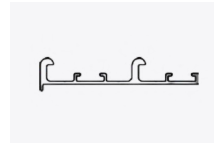

Top Track
*SOLD SEPARATELY

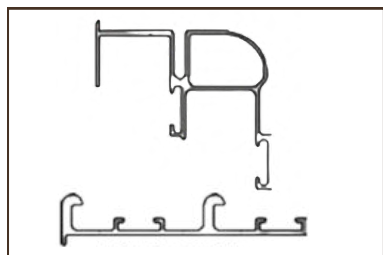

UP AND DOWN ALUMINUM RAIL

FOR RT-602 HANGING SLIDING DOOR SYSTEM

Brand: ALTUS
Material: Aluminum
Packing: Per Piece, with screws

CODE	DESCRIPTION	LENGTH
RT-602-20	Rail for RT-602	3000mm (3 meters)



MIDDLE DOOR DAMPER

for RT-602 Hanging Sliding Door System

Brand: ALTUS
Material: Aluminum
Packing: Per Piece

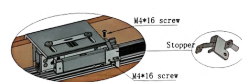

CODE	DESCRIPTION	APPLICATION
RT-602-404	Middle Door Damper for RT-602	for 3-Door



COPLANAR SLIDING DOOR SYSTEM (1750MM)



Brand: ALTUS
Material: Frame: Epoxy Powder Coated Aluminum
 Wheels: POM Material
Door Width: 600-900mm
Door Thickness: 18mm - 45mm
Door Weight Capacity: 20kg (Single Door Panel)
Door Height: Less than 1000mm
Packing: Per Set
Application: Wooden Doors (15-22mm thk), Frame Doors and Aluminum Frame Doors

FEATURES

- Two(2) doors close in 1-piece
- Double Soft Close function
- Cuttable system form 1115-1750mm
- With automatic cleaning brush on runners

CODE	DESCRIPTION	APPLICATION
RT-802	Roller and Damper mechanisms only	Wood

SET INCLUDES:



Right Door Middle Regulator



Right Door Side Regulator



Left Door Middle Regulator



Left Door Side Regulator



Upper Rail



Connecting Rod Component



Door Panel Side Direction Rail





COPLANAR SLIDING DOOR SYSTEM (2050MM)



Brand: ALTUS
Material: Frame: Epoxy Powder Coated Aluminum
 Wheels: POM Material
Door Width: 600-900mm
Door Thickness: 18mm - 45mm
Door Height: Less than 1000mm
Packing: Per Set
Application: Wooden Doors (15-22mm thk), Frame Doors and Aluminum Frame Doors

FEATURES

- Two(2) doors close in 1-piece
- Double Soft close function
- Cuttable system form 1650-2050mm
- With automatic cleaning brush structure

CODE	DOOR WEIGHT CAPACITY	APPLICATION
RT-803	80kg (Single Door Panel)	Wood, Frame & Aluminum Frame



Upper Runner Middle Regulator



Upper Runner Side Regulator



Down Runner Middle Regulator



Down Runner Side Regulator

SET INCLUDES



Upper Rail



Down Rail



Spanner & Spacer



Side Spring

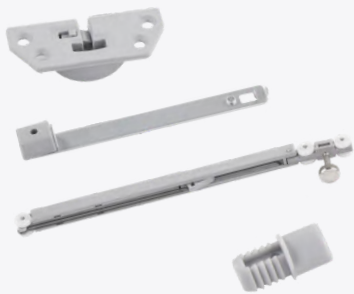

DECORATIVE DOOR SLIDING SYSTEM - WOODEN DOOR

Used for 1 Door only

Brand: ALTUS HARDWARE
Door Width: 20mm - 1200mm
Door Weight: 15kg (Single Door Panel)
Packing: Per Set, 2pcs Wooden Damper, 2pcs Damper Stopper, Positioning Plate, Allen Key (2mm), Mounting Screws and Installation Manual

FEATURES

- External Sliding Door, No cutting or grooving needed.
- Suitable for Decorative Cabinet or Bookcase

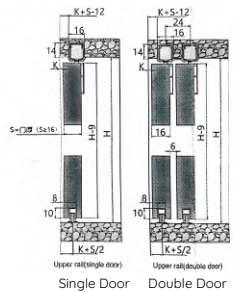

CODE	DOOR THICKNESS	APPLICATION
RT-901W	16mm - 19mm	Wood



DECORATIVE DOOR SLIDING SYSTEM - GLASS DOOR

Used for 1 Door only

Brand: ALTUS HARDWARE
Door Width: 520mm - 1200mm
Door Weight: 15kg (Single Door Panel)
Packing: Per Set, 2pcs Glass Door Damper, 2pcs Damper Stopper, Positioning Plate, Allen Key (2mm), Mounting Screws and Installation Manual

FEATURES

- External Sliding Door, No cutting or grooving needed.
- Suitable for Decorative Cabinet or Bookcase

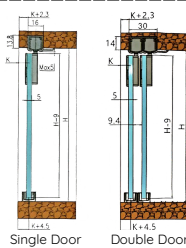

CODE	DOOR THICKNESS	APPLICATION
RT-901L	16mm - 19mm	Glass

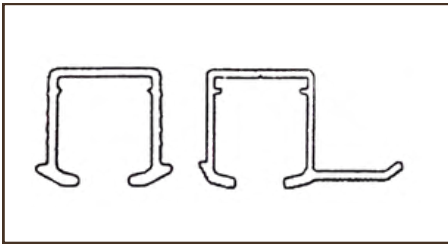

UPPER RAIL SINGLE DOOR
for RT-901L Decorative Door Sliding System

Brand: **ALTUS**
Material: Aluminum
Packing: Per Piece

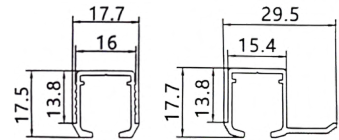

CODE	SIZE
RT-GD160	3000mm (3 Meters)

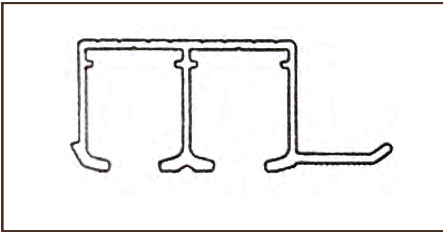

UPPER RAIL FOR DOUBLE DOOR
for RT-901L Decorative Door Sliding System

Brand: **ALTUS**
Material: Aluminum
Packing: Per Piece

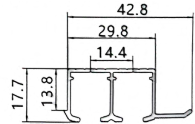

CODE	SIZE
RT-GD161	3000mm (3 Meters)
RT-GD162	3000mm (3 Meters)

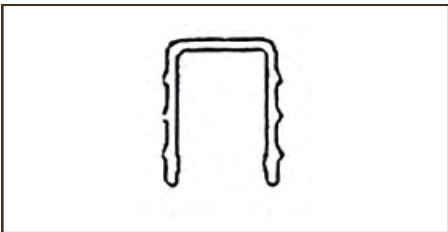

DOWN RAIL FOR SINGLE DOOR
for RT-901L Decorative Door Sliding System

Brand: **ALTUS**
Material: Aluminum
Packing: Per Piece

CODE	SIZE
RT-GD151	3000mm (3 Meters)



FOLD AND SLIDE ROLLER MECHANISM

Brand: **ALTUS**
Material: Chrome Plated Steel
Door Thickness: 18-25mm
Door Width: ≤500mm
Door Height: ≤1200mm
Door Weight: ≤15kgs
Fold Angle: ≤15 degrees
Packing: Per Set



FEATURES

- 2-Door Fold and Slide Mechanism
- Min. gap of 2mm after door closing
- with Door stopper after opening

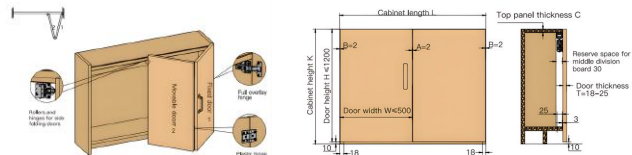

CODE	DESCRIPTION	APPLICATION
RT-909A	Roller and Damper mechanisms only	Wood

SET INCLUDES:



2pcs Upper Roller Mechanism



Rollers & Hinges for Side Folding Doors



2pcs Full Overlay Hinges



2pcs Stopper



2pcs Plastic Hinge

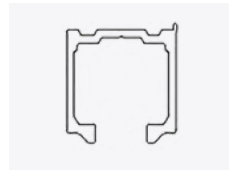

Upper Rail
Code: RT-GD214

SOLD SEPARATELY



FOLD AND SLIDE DOUBLE ROLLER MECHANISM

Brand: ALTUS
Material: Chrome Plated Steel
Door Thickness: 18-25mm
Door Width: ≤500mm
Door Height: ≤2400mm
Door Weight: ≤25kgs
Fold Angle: ≤15 degrees
Packing: Per Set

FEATURES

- 2-Door Fold and Slide Mechanism
- Min. gap of 2mm after door closing
- with Door stopper after opening

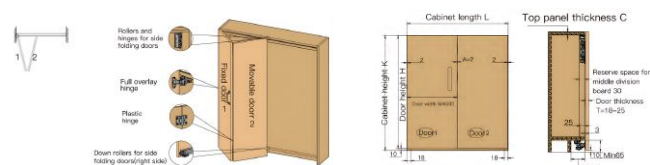

CODE	DESCRIPTION	APPLICATION
RT-909B	Roller and Damper mechanisms only	Wood

SET INCLUDES:

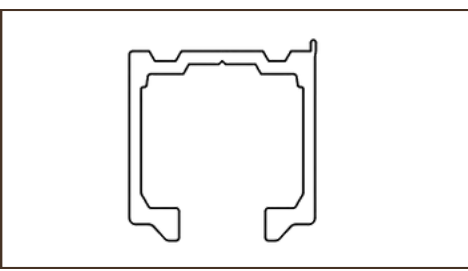

UPPER ALUMINUM RAIL
for RT-909A and RT-909B Fold and Slide Roller Mechanism

Brand: ALTUS
Material: Aluminum
Packing: Per Piece

CODE	SIZE
RT-GD214	3000mm (3 Meters)

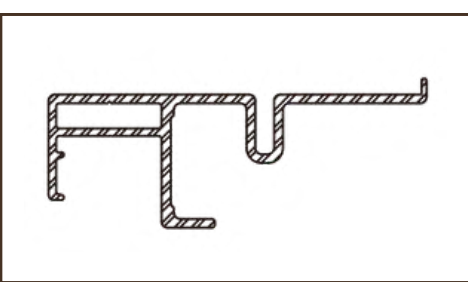

DOWN ALUMINUM RAIL
for RT-909B Fold and Slide Roller Mechanism

Brand: ALTUS
Material: Aluminum
Packing: Per Piece

CODE	SIZE
RT-GD205	3000mm (3 Meters)



POCKET DOOR SYSTEM
with Push To Open Function



Brand: ALTUS HARDWARE
Cabinet Depth: 400-600mm
Cabinet Height: 2400mm/2800mm
Door Thickness: 18-25mm
Door Weight: 18-25kgs
Capacity: 35kgs
Packing: Per Set, includes Upper Rail Assembly (Left/Right), Middle Rail Assemble (Left & Right), Down Rail Assembly (Left/Right), Upper Rail Guide Wheel (Left & Right), Middle Rail Guide Wheel (Left & Right), Down Rail Guide Wheel (Left & Right), Profile Handle Assemble (Left & Right), Decorative Brushes, Decorative Brushes Rail, Door Stop Buffer, Side Sealer Rail, Aluminum for Positioning, Side Mounted Guide Wheel, Hinges (Left/Right) and Installation Manual

Optional: Buffer RT3003 for soft close mechanism

FEATURES

- 2-Door Fold and Slide Mechanism
- Min. gap of 2mm after door closing
- with Door stopper after opening

CODE	SIZE	COLOR
RT-926.A.LEFT	2001-2400mm	Aluminum Silver
RT-926.A.RIGHT	2001-2400mm	Matte Black
RT-926.B.LEFT	2401-2800mm	Shiny Gold
RT-926.B.RIGHT	2401-2800mm	Rose Gold

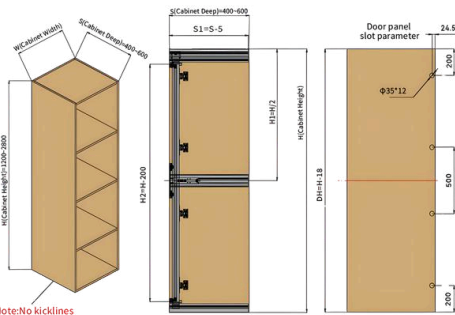

Opening clearance value

W	1	2	3	4	5	6	7	8	9	10	11	12	13	14	15	16	17	18	19	20	21	22	23	24	25
H	0	0	0	0	0	0	0	0	0	0	0	0	0	0	0	0	0	0	0	0	0	0	0	0	0
W	0	0	0	0	0	0	0	0	0	0	0	0	0	0	0	0	0	0	0	0	0	0	0	0	0
H	0	0	0	0	0	0	0	0	0	0	0	0	0	0	0	0	0	0	0	0	0	0	0	0	0

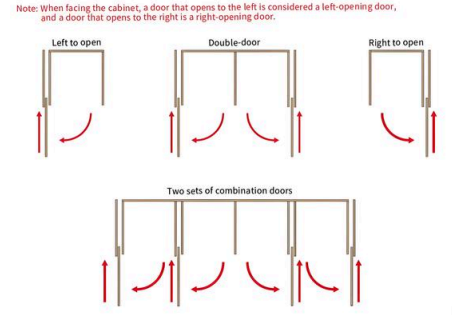
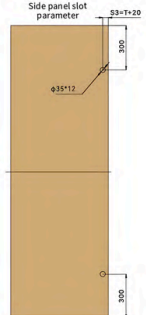
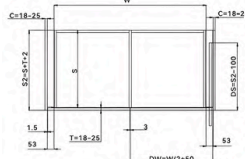

SET INCLUDES:

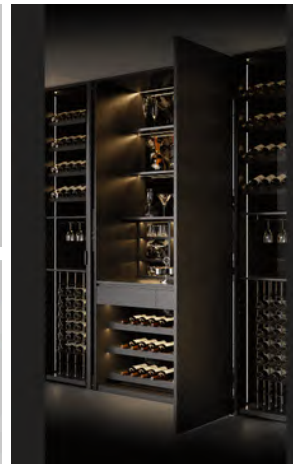
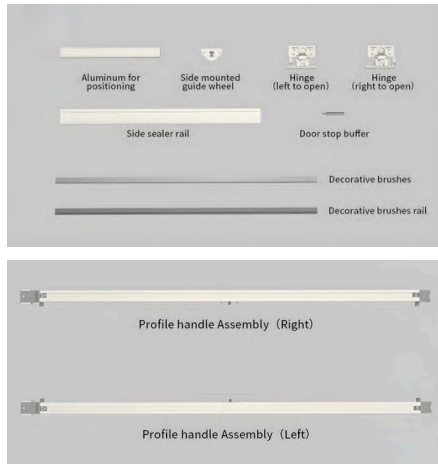
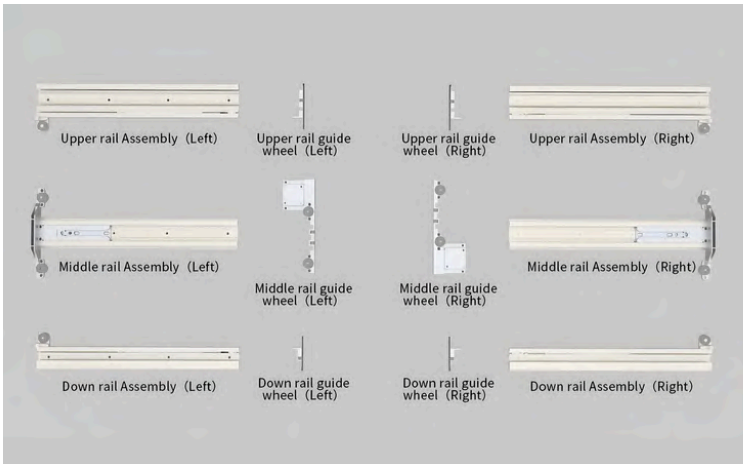



SLIDING DOOR

PARTITION SYSTEMS



DOUBLE SOFT CLOSING SLIDING MECHANISM (2-DOOR SYSTEM)



Brand: ALTUS
Series: Mira
Material: Frame: Epoxy Powder Coated Aluminum
 Pulley: POM Material
Door Width: 580mm - 1200mm
Door Height: up to 3000mm (maximum)
Door Weight Requirement: 60-100kgs
Glass Door Thickness: 8mm
Packing: Per Set, with installation manual

FEATURES

- Easy Installation
- No Need Slotting
- Smooth and Silent Sliding Mechanisms

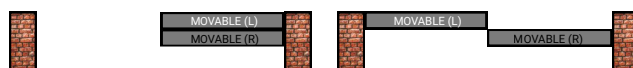

CODE	APPLICATION	DOOR THICKNESS
MIRA MR905L SYSTEM	Aluminum	8mm
MIRA MR905W SYSTEM	Wood	35-60mm

SET INCLUDES:



Runner and Stopper



Bottom Guide



Hanging Plate

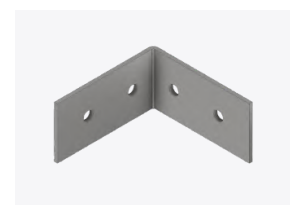

Connector
***SOLD SEPARATELY**

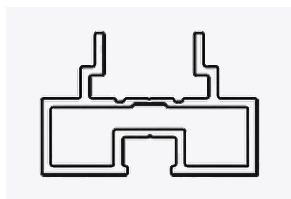

Horizontal Frame
***SOLD SEPARATELY**

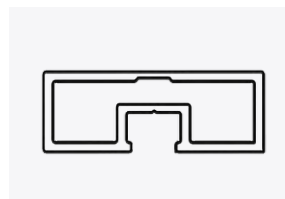

Vertical Frame
***SOLD SEPARATELY**

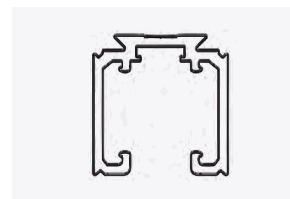

Upper Rail
***SOLD SEPARATELY**

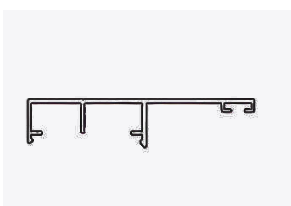

Upper Rail Deco Cover
***SOLD SEPARATELY**
OPTIONAL

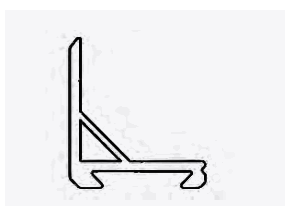

Side Mount Plate
***SOLD SEPARATELY**

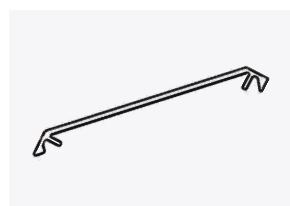

Side Mount Cover
***SOLD SEPARATELY**
OPTIONAL



LINK HANGING SLIDING PARTITION DOOR
2+1Fixed Doors



Brand: ALTUS
Series: Mira
Material: Frame: Epoxy Powder Coated Aluminum
 Pulley: POM Material
 Standard Damper
Type:
Door Thickness: 30mm - 50mm
Door Width: 580mm - 1200mm
Door Weight: ≥80kgs
Application: bathroom, bedroom, study and other partition doors
Packing: Per Set, with Installation Manual

FEATURES

- Easy Installation - door panel height can be adjusted after installation.
- No Bottom Track Design - very safe for the elderly and children.
- Smooth and Silent Sliding Mechanisms
- Produced with high-quality control standards, which has passed the 24 hours salt-spray.

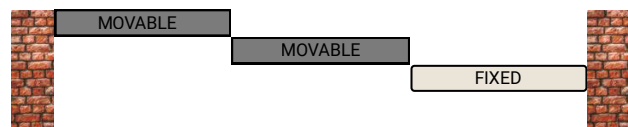

CODE	APPLICATION	APPLICATION
MIRA MR910W	Roller and Damper mechanisms only	Wooden Door
MIRA MR910W	Fixed Door Accessories	Wooden Door
MIRA MR910L	Roller and Damper mechanisms only	Aluminum Door
MIRA MR910L	Fixed Door Accessories	Aluminum Door

SET INCLUDES:



Runner and Stopper



Connector
*SOLD SEPARATELY

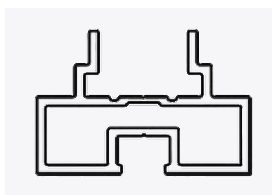

Horizontal Frame
*SOLD SEPARATELY

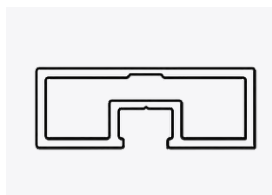

Vertical Frame
*SOLD SEPARATELY

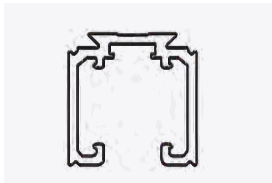

Upper Rail
*SOLD SEPARATELY



Upper Rail Deco Cover
*SOLD SEPARATELY
OPTIONAL



Middle Frame
*SOLD SEPARATELY
OPTIONAL

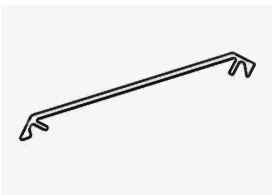

Side Mount Cover
*SOLD SEPARATELY
OPTIONAL

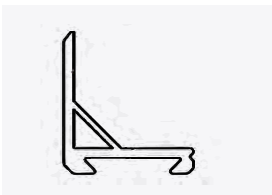

Side Mount Plate
*SOLD SEPARATELY



HANGING SLIDING PARTITION DOOR
2+2 Fixed Doors



Brand: ALTUS
Series: Mira
Type: Standard Damper
Door Thickness: 35mm - 60mm
Door Width: 820mm-1200mm
Door Weight: ≥80kgs
Packing: Per Set, includes 1pc Outside Roller, 1pc Inside Rollers with Damper, 1pc Inside Rollers, 1pc Outside Rollers with Damper, 1pc Belt Fixing Part, 2pcs Damper Stopper, 2pcs Linkage Runner Guider, Transmission Belt (12m), 2pcs Down Guider, 4pcs Anti-Slip Off Parts, Allen Keys, Mounting Screws and Installation Manual

Application: Bathroom, bedroom, study and other partition doors

FEATURES

- Double Soft Close Function - smooth and silent.
- No Bottom Track Design - very safe for the elderly and children.
- Produced with high-quality control standards, which has passed the 24 hours salt-spray.

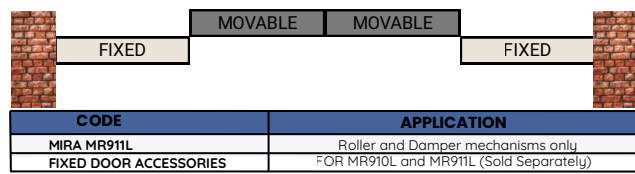

SET INCLUDES:



Rollers with Dampers, Down Guider, and Anti-Slip Off Part

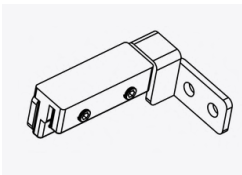

Belt Fixing Part

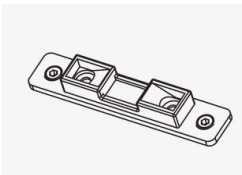

Damper Stopper

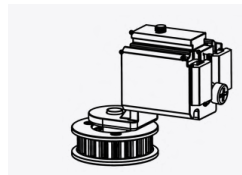

Linkage Runner Guider

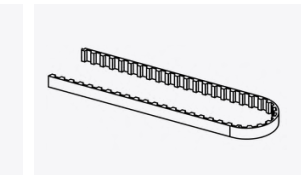

Transmission Belt (12m)

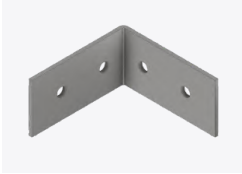

Connector
*SOLD SEPARATELY

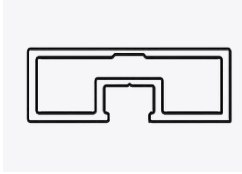

Vertical Frame
*SOLD SEPARATELY

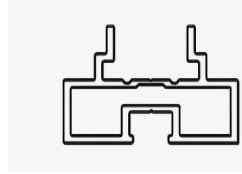

Horizontal Frame
*SOLD SEPARATELY

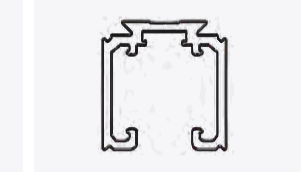

Upper Rail
*SOLD SEPARATELY

***OPTIONAL (SOLD SEPARATELY)**

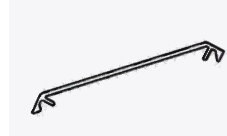

Side Mount Cover

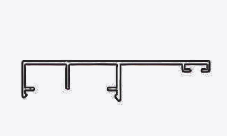

Upper Rail Deco Cover

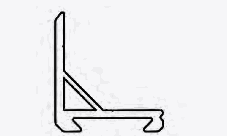

Side Mount Plate



Middle Frame



INVISIBLE RAIL SLIDING DOOR SYSTEM

Concealed Rear Partition Door



Brand: ALTUS
Series: Mira
Door Thickness: ≥40mm
Door Width: 800mm-1220mm
Doorway Width: 533mm - 953mm (Door Fully Open)
 650mm - 1070mm (Door Partially Open)
Door Weight: ≥80kgs
Packing: Per Set, includes 1pc Upper Runner, 2pcs Soft Close Device, 2pcs Side Runners, 1pc Down Guide Roller, 2pcs Down Runner, 1pcs End Plug, 1 Rail, 1pc Down Rail, Mounting Screws, Allen Wrench & Installation Manual

Application: Bathroom, bedroom, study and other partition doors

FEATURES

- Hidden Track Partition Door
- Sliding Door Anti-Drop System
- Removable Buffer/Damper Positioning
- Flexible Adjustment, easy and convenient
- Smooth and Quiet
- Simple, convenient and Quick Installation
- 3D Flexible Adjustment (Up and Down, Distance to Wall and Door Level)
- Space-Saving: Features concealed tracks, maintaining a sleek, minimalist look.
- Seamless Design: Hidden tracks maximize space, creating an open, unobstructed feel.
- Smooth Operation: A buffer mechanism ensures effortless sliding, while the track-free floor allows easy cleaning.

MOVABLE	
CODE	APPLICATION
MIRA MR912W	Roller and Damper mechanisms only

SET INCLUDES:

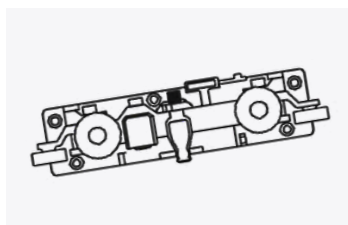

Upper Runner

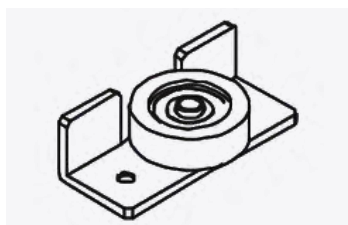

Side Runner

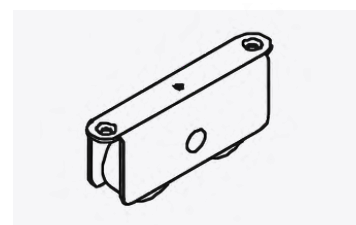

Down Runner

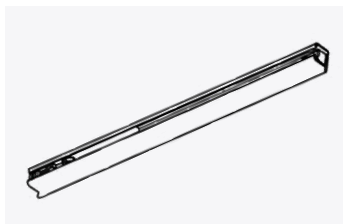

Soft Close Device

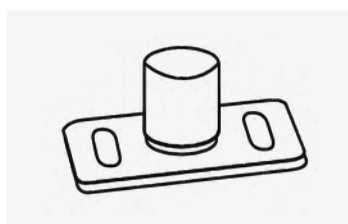

Down Guide Roller

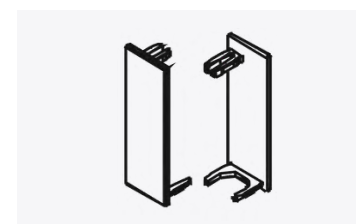

End Plugs

UP AND DOWN ALUMINUM RAIL
 FOR RT-912 HANGING SLIDING DOOR SYSTEM

Brand: ALTUS
Material: Aluminum
Packing: Per Set

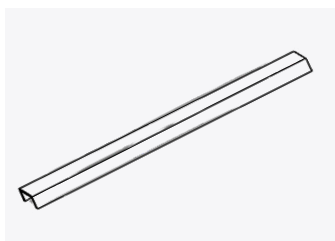

Down Rail

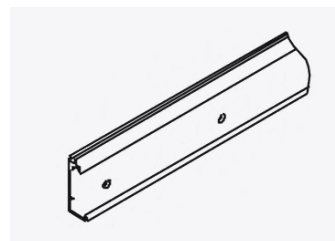

Rail

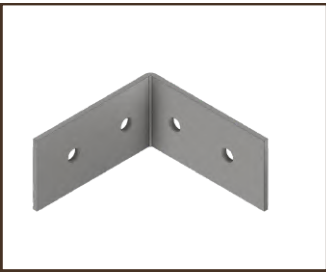

MIRA CONNECTOR
FOR MR905L / MR905W / MR910L / MR910W / MR910L

Brand: ALTUS
Material: Aluminum
Packing: Per Piece, with screws

CODE	SIZE
GD - 903C	3000mm (3 Meters)

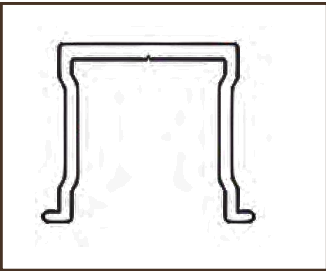

MIRA DOWN RAIL
FOR MR905W & MR910W

Brand: ALTUS
Material: Aluminum
Packing: Per Piece

CODE	SIZE
GD - 181	3000mm (3 Meters)

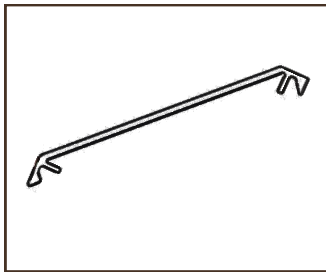

MIRA SIDE MOUNT COVER

Brand: ALTUS
Material: Aluminum
Packing: Per Piece

CODE	SIZE
GD - 182	3000mm (3 Meters)

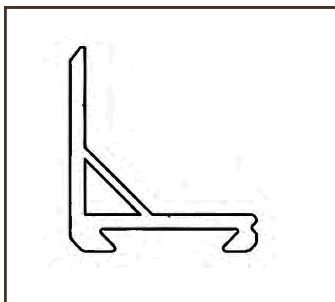

MIRA SIDE MOUNT PLATE

Brand: ALTUS
Material: Aluminum
Packing: Per Piece

CODE	SIZE
GD - 183	3000mm (3 Meters)

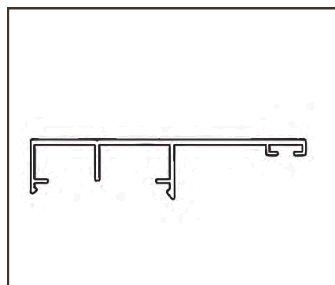

MIRA UPPER RAIL COVER (DECO COVER)
FOR MR905L / MR905W / MR910L / MR910W

Brand: ALTUS
Material: Aluminum
Packing: Per Piece

CODE	SIZE
GD - 186	3000mm (3 Meters)

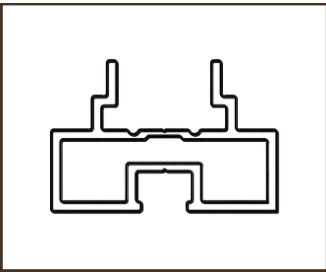

MIRA HORIZONTAL FRAME
FOR MR905L / MR905W / MR910L / MR910W / MR911L

Brand: **ALTUS**
Material: Aluminum
Packing: Per Piece

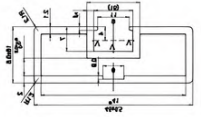

CODE	SIZE
GD - 246	3000mm (3 Meters)

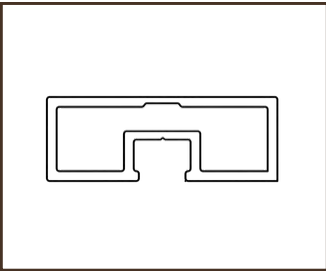

MIRA VERTICAL FRAME
FOR MR905L / MR905W / MR910L / MR910W / MR910L

Brand: **ALTUS**
Material: Aluminum
Packing: Per Piece

CODE	SIZE
GD - 247	3000mm (3 Meters)



MIRA MIDDLE FRAME (OPTIONAL)
FOR MR905L / MR905W / MR910L / MR910W / MR910L

Brand: **ALTUS**
Material: Aluminum
Packing: Per Piece

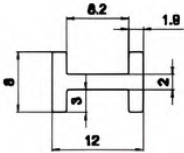

CODE	SIZE
GD - 248	3000mm (3 Meters)

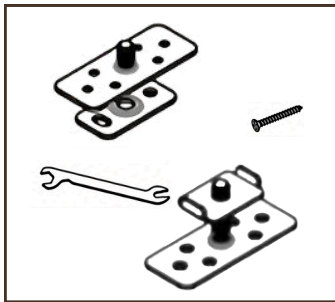

MIRA FIXED DOOR ACCESSORIES

Brand: **ALTUS**
Application: For Wooden Door only
Packing: Per Set 2pcs Fixed Door Upper accessory, 2pcs Fixed Door Bottom accessory, 28pcs ST4*30 Self tapping wood screw, 1pc 12-6 outer hexagon spanner

CODE	APPLICATION
MIRA FIXED DOOR ACCESSORIES	MR910W & MR911W

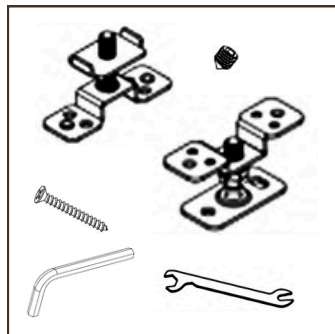

MIRA FIXED DOOR ACCESSORIES

Brand: **ALTUS**
Application: For Glass Aluminum Door only
Packing: Per Set, 2pcs Fixed Door Upper accessory, 2pcs Fixed Door Bottom accessory, 4pcs ST4*30 Self tapping wood screw, 8pcs M5 locking screw, 1pc Allen Key and 1pc 12-6 outer hexagon spanner

CODE	APPLICATION
MIRA FIXED DOOR ACCESSORIES	MR910L & MR911L



EVA HOT MELT GLUE

FOR FURNITURE EDGE BANDING

Brand: Jowat
Application: PVC, paper, and polyester, laminate edges, ABS edges, veneer edges
Colors: White/Beige Natural
Packing: Granules/25kgs/Sack

FEATURES

- Modern adhesive systems of the latest generation.
- Furniture edges with "zero bondline".
- Hot melt adhesives for the current technologies.
- High initial strength, good heat resistance.

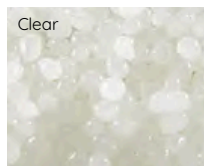
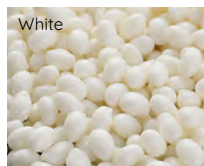

CODE	PROCESSING TEMPERATURE	TYPE OF MACHINE	COLOR
280.58	190-210°C	Automatic	Clear
282.20	130-150°C	Handheld/Manual Push	Beige Natural
282.21	130-150°C	Handheld/Manual Push	White
284.70	180-200°C	Automatic	Beige Natural
284.71	180-200°C	Automatic	White
296.00	190-210°C	Automatic	Beige Natural
296.01	190-210°C	Automatic	White



PUR HOT MELT GLUE

FOR FURNITURE EDGE BANDING

Brand: Jowat
Application: HPL/CPL, Polyester, PVC, ABS, PP, Resinated Paper, Solid Wood or Veneer
 Can be used for straight edges, soft forming and machining centers.
Colors: White/Beige Natural
Packing: 600gms/Tin Can Granulate / 9cans per carton

Processing Temperature: 130°C -150°C
Ideal feed Rate: 12-30m/min
Open time at 140°C: 8 ± 2 s

PROPERTIES AND PROCESSING INSTRUCTIONS:

- Long open time, high heat tack, good adhesion, good heat resistance; excellent oxidation and color stability in the melt.
- Very good machine running properties with precise, thread-free hot melt application.
- Excellent initial strength combined with rapid setting.
- Can be processed on automatic systems with roller and slot die.
- Processing with special equipment from moisture-tight containers.

Viscosity at 140°C/Temperature [°C]: 60,000mpas
Density at 23°C: 1.35 ± 0.05g/cm3

CODE	PROCESSING TEMPERATURE	TYPE OF MACHINE	COLOR
607.40	130°C -150°C	Automatic	Natural Beige
607.41	130°C -150°C	Automatic	White



PUR FLUSHING GLUE

FOR FURNITURE EDGE BANDING

Brand: Jowat
Application: Jowat Adhesives
 Flushing of melting units and hoses.
 Contains a reaction inhibitor.
 Medium viscosity.
Appearance: Red, Granulate
Packing: 20kg/Sack

Density [g/cm³] / Temperature [°C]: 0,95 / 20
Softening Range (Kofler) [°C]: 80
Viscosity [mPas] / Temperature [°C]: 20000 / 120



CODE	PROCESSING TEMPERATURE	TYPE OF MACHINE	COLOR
930.74	100 - 140°C	Automatic	Red



INTERIOR
SURFACE SOLUTIONS

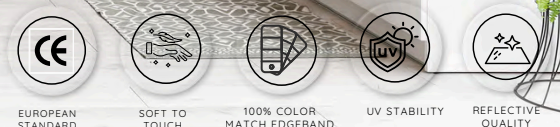

AERIN GLOSS

UV BOARDS

- Size: 2440 x 1220mm x 18mm thickness
- European Standard MDF
- High Gloss Finish
- Double Side
- Color Match PVC Edgeband (Size: 1 x 22mm)

			ALSO AVAILABLE IN PLYWOOD	ALSO AVAILABLE IN PLYWOOD
RSAEG-01 White Marble	RSAEG-02 Black Marble	RSAEG-03 Brown Marble	RSAEG-06 White	RSAEG-07 Khaki

SENTIR

SYNCHRONIZED - PB BOARDS

- Size: 2440 x 1220mm x 18mm thickness
- Italian Designed Laminate with Texture
- European Standard Particle Board
- Double Side
- PVC Edgeband (1 x 22m) Color Match



RSSSEN-01 Dark Brown	RSSSEN-02 Light Brown	RSSSEN-03 Medium Brown	RSSSEN-04 Reddish Brown	RSSSEN-05 Beige Brown	RSSSEN-06 Grey Synchron
RSSSEN-07 White Synchron	RSSSEN-08 Stone Dark Grey	RSSSEN-09 Stone Light Grey	RSSSEN-10 Acacia	RSSSEN-11 Linen Beige	RSSSEN-12 Linen Grey

LUX MATTE

ANTI-FINGER PRINT AND SCRATCH RESISTANT BOARDS

- Size: 2440 x 1220mm x 18mm thickness
- European Standard MDF
- Soft -Touch Matte Finish
- Thermal-Healing Surface
- High Scratch Resistance
- Anti-Fingerprint Surface
- Color Match Edgeband (Size: 1 x 22mm)

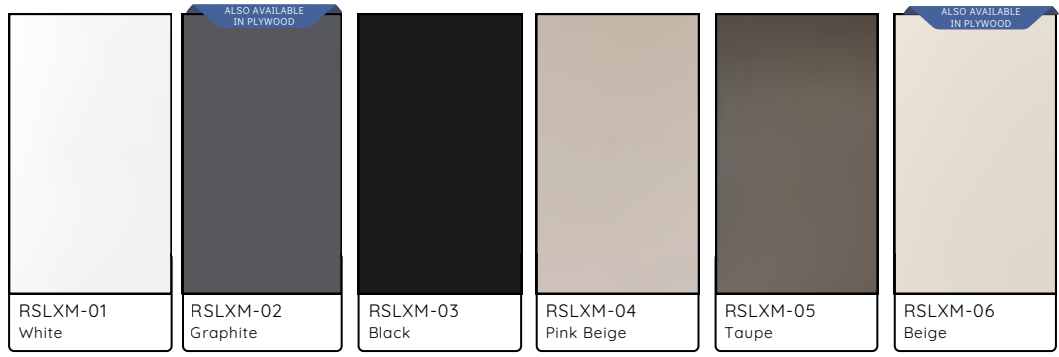

LUX GLOSS

PET GLOSSY BOARDS

- Size: 2440 x 1220mm x 18mm thickness
- European Standard MDF
- High Gloss Finish
- Double Side
- Anti-Scratch Properties
- Color Match PVC Edgeband (Size: 1 x 22mm)



LAMINATED BOARDS

- Size: 2440 x 1220mm x 18mm thickness
- European Standard Particle Board
- Double Side
- Texturized Board
- PVC Edgeband (1 x 22m) Color Match

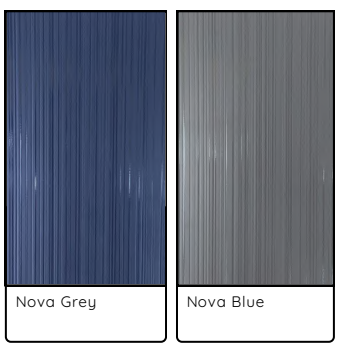

ALITHA COMPACT HPL

- Durable and 100% waterproof, and self-supporting solid panel made from layers of resin-impregnated kraft paper.
- It is highly resistant to moisture, stains, impact, and heat, making it ideal for modern, minimalist kitchens and high-traffic areas.
- Ideal as Countertops and Toilet partition with our Large Format size of 1320mm x 3050mm



ALSO AVAILABLE:



RAUVISIO BRILLIANT
THE HIGH GLOSS LAMINATE

RAUVISIO CRYSTAL
THE GLASS LAMINATE

RAUVISIO BRILLIANT SR
THE HIGH GLOSS LAMINATE

RAUVISIO CRYSTAL SLIM
POLYMER GLASS PANEL

Facebook: @alithaindcorp
Instagram: @alithaindustrial
Tiktok: @alithaindustrial

ALITHA INDUSTRIAL CORPORATION

Catalog 2026

ALTUS
HARDWARE

PREMIO ITALIA
FURNITURE HANDLES



REHAU

• **freud**

• **Jowat**
Adhesives 